

# 315F L

Hydraulic Excavator



## Engine

Engine Model	Cat® C4.4 ACERT™	
Net Power – SAE J1349	72 kW	97 hp

## Drive

Maximum Travel Speed	5.4 km/h	3.4 mph
Maximum Drawbar Pull	113 kN	25,400 lbf

## Weight

Minimum Operating Weight	15 040 kg	33,160 lb
Maximum Operating Weight	16 480 kg	36,340 lb

## Introduction

*The new Cat 315F compact radius excavator features a U.S. EPA Tier 4 Final C4.4 ACERT engine that's miserly on fuel paired with a state-of-the-art hydraulic system that's responsive to your every command. Each pull of the joysticks will feel like a natural extension of yourself, providing you with smooth, controlled power to take on the work in front of you with speed, precision, and confidence.*

*When you add in robust structures that keep you grounded and balanced, an operator environment that enhances your comfort and productivity, service points that make your routine maintenance fast and simple, available Cat Grade Control to help you create precise planes and slopes with ease, and multiple Cat work tools and tool control system that enable you to quickly take on a variety of tasks, you simply won't find a better built, more reliable, more versatile, or more rewarding excavator in its size class – from any company, anywhere.*

*Bottom line: If your work takes you in to tight spaces and you need the absolute best performance at the lowest cost per unit of work that you can possibly get from a 15-ton excavator, take along a Cat 315F. You will be glad you did.*

## Contents

Hydraulics .....	4
Engine .....	6
Compact Radius .....	7
Operator Station.....	8
Integrated Technologies.....	9
Front Linkage .....	10
Structures & Undercarriage .....	11
Attachments.....	12
Serviceability.....	14
Safety .....	15
Complete Customer Care.....	16
Sustainability .....	17
Specifications.....	18
Standard Equipment.....	34
Optional Equipment.....	35





### Key Performance Stats & Facts

**Maximum Lift without Limitation\***

4050 kg (8,750 lb) without bucket  
\*Ground level, 4.5 m (15'0") to the side

**Maximum Bucket Size**

0.76 m<sup>3</sup> (1.0 yd<sup>3</sup>) 1200 mm (48")

**Maximum Reach**

8680 mm (28'6")

**Maximum Dig Depth**

5950 mm (19'6")

# Hydraulics

You can move dirt, rock, and debris with speed, precision, and efficiency





### **A Forceful, Responsive Design**

The 315F features a negative flow control hydraulic system that gives you the feel and response of an open center valve system with the efficiency of a closed center valve system. In layman's terms, negative flow control decreases pump flow when oil pressure in the center bypass increases and vice versa. The net result is the pump and valve operate in harmony with less energy and less wear and tear.

### **A Logical Layout**

All major hydraulic components are strategically located close together. This positioning leads to reduced friction loss and pressure drops, and the result is more hydraulic horsepower for the heavy-lifting, ground-breaking work you need to get done.

### **Valves For Added Efficiency**

The 315F is built with a back-to-back main control valve, and the benefit to you is reduced pressure loss and fuel consumption due to the shorter distance oil has to travel. The machine also features special boom and stick valves that recirculate oil flow in the cylinders during work instead of going all the way back to the tank. The valves contribute to energy savings, but their primary benefit is allowing more oil to flow to other functions so you can experience faster cycle times and more production.

### **Filter For Added Protection & Performance**

The capsule filter is designed to take out impurities and help you avoid system contamination and accidental spilling. The self-contained, maintenance-friendly filter is easy to remove with a simple wrench. It can take out impurities as small as beta 10 – particles so tiny you cannot see them with the eye. A sensor lets you know if there is a clog or if pressure exceeds a certain level so you can take action.

### **Drain Filter**

A drain filter is one extra level of contamination prevention the 315F offers. Located in the pump compartment behind the pilot filter, the drain filter purifies the case drain from the main pumps, swing motor, and travel motors – all to enhance the life of the pumps and motors and uptime for you.

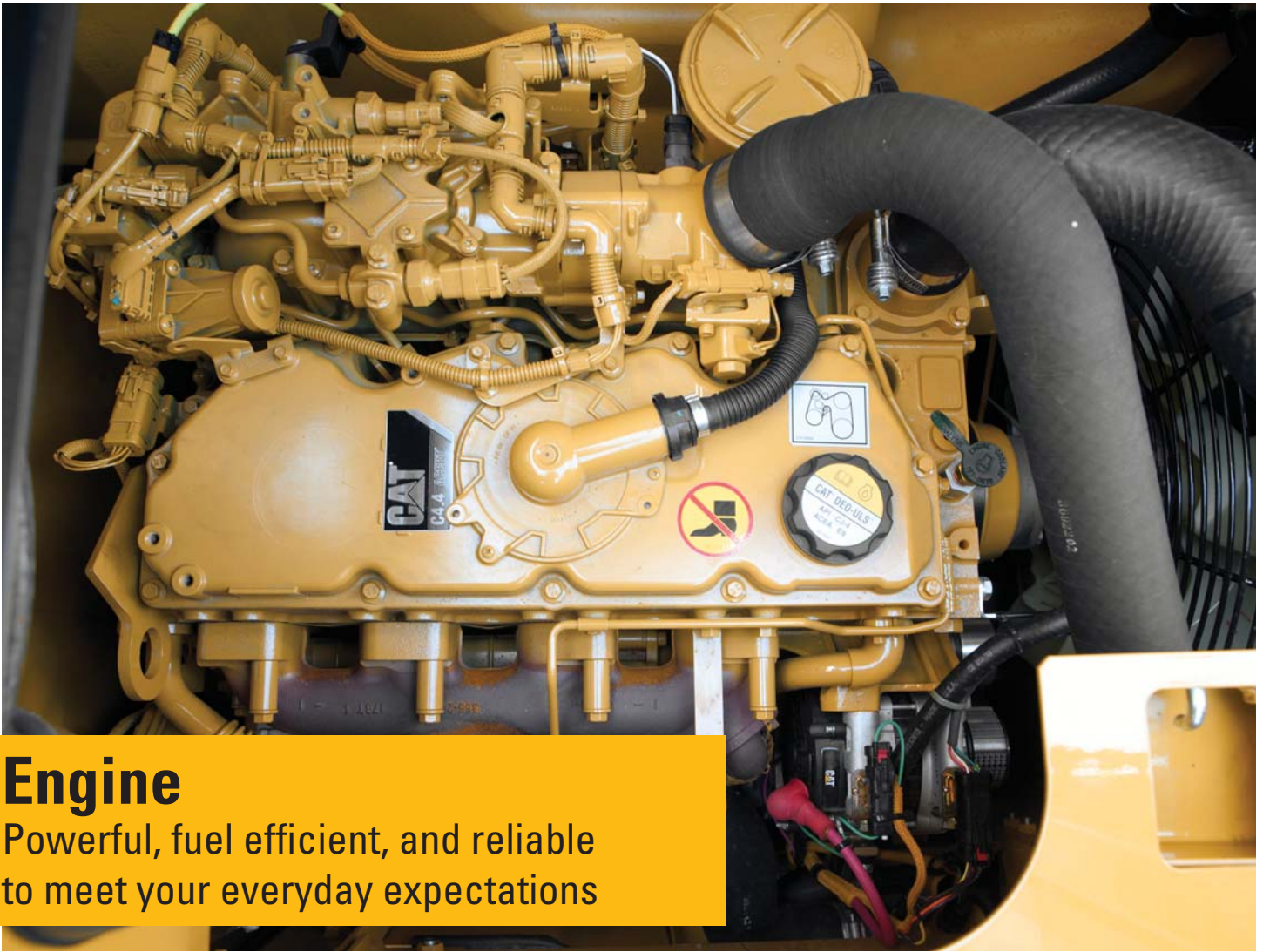

# Engine

Powerful, fuel efficient, and reliable to meet your everyday expectations

## Proven Technology

Every Tier 4 Final ACERT engine is equipped with a combination of proven electronic, fuel, air, and aftertreatment components. Applying these time-tested technologies lets us meet your high expectations for productivity, fuel efficiency, reliability, and service life.

Following are the results you can expect:

- High performance across a variety of applications.
- Enhanced reliability through commonality and simplicity of design.
- Maximized uptime and reduced cost with world-class Cat dealer support.
- Minimized impact on emission systems – with no operator interaction required.
- Durability with long service life.
- Same great power and response.
- Biodiesel capability to give you more potential fuel-saving flexibility.

# Compact Radius

Sized right for tight quarters work



## Work With Confidence

The 315F L's compact radius design makes it ideal for working confidently in space-restricted areas like road jobs with lane closures and next to buildings or other structures you'd like to keep from harm's way. With a front swing radius of 2.27 m (7'5") and a tail swing radius of 1530 mm (5'0"), the machine can dig, swing, and dump within a working space of 3.8 m (12'5"). When rotated 90 degrees and working over the side, just 135 mm (5") of counterweight extends beyond the track width, which allows trucks and jersey barriers to be positioned closer to the machine.

## Work With Power

Unlike a standard radius machine, the 315F's boom is positioned toward the center of the machine. Not only does this help reduce the front swing radius, but it also supports more lift capacity over the front due to greater stability.

## Work With Comfort

The machine features a full-size ROPS-certified cab. With low sound levels, high visibility, convenient access to switches and controls, and a fully adjustable seat, you will find it comfortable to work in all day long.

# Operator Station

Your operators will enjoy the incredibly quiet and comfortable cab



## A Safe, Quiet Cab

The Roll-Over Protective Structure (ROPS) cab provides you with a safe working environment. It also contributes to your comfort because it's attached to a reinforced frame with special viscous mounts that limit vibration and unnecessary sound. Add in special roof lining and sealing and you have a cab that's as quiet inside as today's top pickup trucks.

## Comfortable Seat

The seat is an air suspension type with heat. It features a reclining back, upper and lower slide adjustments, and height and tilt angle adjustments to meet your needs for maximum comfort.

## A Cool & Warm Environment

The automatic climate control system features multiple air outlets with filtered ventilation. Air flows on the floor, behind the seat, and in front of you to make your work in either hot or cold weather much more pleasant and productive.

## Controls Just For You

The joystick consoles adjust to improve your comfort and productivity during the course of a day. The armrests telescope up and down just like a bicycle seat. Joysticks for tool control have buttons to make working with a two-way-flow grapple, thumb, and shear simple. The right joystick features a button that will reduce engine speed when you are not working to help save fuel. Touch it once and speed reduces; touch it again and speed increases for normal operation.

## A Helpful Monitor

The LCD monitor is easy to see and navigate. Programmable in up to 44 languages to meet today's diverse workforce, the monitor clearly displays critical information you need to operate efficiently and effectively. Plus it projects the image from the standard rearview camera to help you see what's going on around you so you can stay safely focused on the job at hand.

## Ample Storage & Auxiliary Power

Storage spaces are located in the front, rear, and side consoles of the cab. A drink holder accommodates a large mug, and a shelf behind the seat stores large lunch or toolboxes. Two 12-volt power supply sockets are conveniently located near the key storage areas for charging your electronic devices like an MP3 player, a cell phone, or a tablet.





# Integrated Technologies

Monitor, manage, and enhance your job site operations



## Cat Connect

The smart use of technology and services will improve your job site efficiency. In fact, using data from technology-equipped machines give you more information and insight into your equipment and operations than ever before.

Cat Connect technologies offer improvements in these key areas:

- **GRADE Technologies**

GRADE technologies like Cat Grade Control Depth and Slope combine digital design data and in-cab guidance to help you work more productively and accurately with less rework. Real-time bucket tip positioning and cut and fill data on the standard cab monitor guide you to grade, saving money on fuel and materials.

- **LINK Technologies**

LINK technologies like Product Link™ wirelessly connect you to your equipment, giving you valuable insight into how your machine or fleet is performing. The system tracks location, hours, fuel usage, productivity, idle time, and diagnostic codes through the online VisionLink® interface so you can make timely, fact-based decisions to maximize efficiency, improve productivity, and lower operating costs.



## Front Linkage

Options to take on your far-reaching and up-close tasks

### Link & Pins

The power link between the stick and bucket is designed for heavy-duty lifting over the long haul. With an integrated lifting eye, the power link helps enhance lifting capability by lowering your load point and maximizing the power built into the boom cylinders. All pins used in the front linkage have thick chrome plating to give them high wear and corrosion resistance. The large pins distribute load weight to ensure long pin, boom, and stick life.

### Booms

Two types of booms are available to meet a variety of tasks. A reach boom offers you excellent all-around versatility and a large working envelope; a power offset boom allows you to stay in the same position to load and dump, which increases productivity when your team is working in narrow, restricted space. A unique bucket-to-cab avoidance feature is also included to ensure safe operation.

### Sticks

The R3.0 m (9'10") stick is best for when you need deep trenching, longer reach, and top truck loading capabilities. The R2.8 m (9'2") stick provides greater breakout force and increases productivity when you primarily plan on using hydro-mechanical work tools. The 2.13 m (6'11") stick combines with the power offset boom to deliver excellent breakout force and cycle speed in those tough-to-reach places.

### Built To Last

Each boom and stick is built with internal baffle plates for additional durability, and each undergoes ultrasound inspection to ensure quality and reliability. Large box-section structures with thick, multi-plate fabrications, castings, and forgings are used in high-stress areas such as the boom nose, boom foot, and boom and stick cylinders to enhance durability for the tough work you do. Your Cat dealer can help you pick the best combination for your business.

# Structures & Undercarriage

You can take on a variety of tough tasks with this built-to-last machine



The 315F L is a well-built machine designed to give you a very long service life. The upper frame has mountings made specifically to support the heavy-duty cab; it's also reinforced around key areas that take on stress like the boom foot and skirt. Massive bolts are used to attach the track frames to the body, and additional bolts are used throughout to increase the machine's digging force, which leads to more productivity for you.



## Durable Undercarriage

The 315F L undercarriage contributes significantly to its outstanding stability and durability. Track shoes, links, rollers, idlers, and final drives are all built with long-lasting, high-tensile-strength steel. Cat Grease Lubricated Track 2 (GLT2) track link protects moving parts by keeping water, debris, and dust out and grease sealed in, which delivers longer wear life and reduced noise when traveling. Optional guide guards help maintain track alignment to improve the machine's overall performance – whether you're traveling on a flat, heavy bed of rock or a steep, wet field of mud.



## Great Weight

The 315F L has one counterweight option. Rounded to minimize the amount of overhang, the 3.56 mt (3.9 t) weight is mounted directly to the main frame using massive bolts to ensure maximum rigidity. Plus it has an integrated housing to help protect the machine's standard rearview camera.

# Attachments

Tools to make you productive and profitable



## Get The Most Out Of One Machine

You can easily expand the performance of your machine by utilizing any of the variety of attachments offered by Cat Work Tools.

## Change Jobs Quickly

A quick coupler brings the ability to quickly change attachments and switch from job to job. The Cat Pin Grabber coupler is the secure way to decrease downtime and increase job site flexibility and overall productivity.

## Dig, Finish & Compact

A wide range of buckets dig everything from top soil to harsh, abrasive material. For finishing and grading work, compact and shallow ditch cleaning buckets fit the need. A Cat compactor prepares the area for the next phase of construction.

## Break, Demolish & Scrap

A hydraulic hammer equips your machine for breaking rock in quarries, preparing trenches on construction sites, or taking down bridge pillars and reinforced concrete on road jobs. Shears take your machine into demolition jobs and help you process the debris for reuse and recycle.

## Move & Handle

Add a thumb and you have the ability to move and handle brush, rocks, and debris. For constant material handling, a grapple is your solution.

## Set Up Your Machine For Profitability

Your Cat dealer can install hydraulic kits to properly operate all Cat Work Tool attachments – maximizing the machine's uptime and your profits. All Cat Work Tool attachments are supported by the same Cat dealer network as your Cat machine

**GRAB, SORT, LOAD**



**Pro Series Hydraulic Thumbs**



**Stiff Link Thumbs**



**Contractors' Grapples**



**Trash Grapples**

**DIG & PACK**



**Ditch Cleaning and Tilt Buckets**



**General Duty Buckets**



**General Duty, Wide Tip Buckets**



**Severe Duty Buckets**



**Vibratory Plate Compactors**

**SWAP TOOLS**



**Pin Grabber Coupler**

**CUT, CRUSH, BREAK & RIP**



**Scrap & Demolition Shears**



**Hydraulic Hammers**

# Serviceability

Designed to make your maintenance quick and easy

## On-Board Monitoring

The 315F has a pre-start monitoring system that allows you to check coolant, hydraulic oil, and engine oil levels right inside the cab. The monitor also tells you fluid and filter change intervals to ensure you keep the machine in top-performing condition.

## Safe, Convenient Access

You can see the service hour meter inside the cab and reach most routine maintenance items like fluid taps and grease points from the safety and convenience of ground level. Filters are banked together for higher service efficiency. Compartments feature wide service doors and heavy-duty hardware to keep them open – all to make service work simpler and more secure.

## A Fresh Idea

The fresh air filter is conveniently located on the side of the cab to make it easy for you to reach and replace. It's protected by a lockable door that can only be opened with the engine key.

## A Priming Solution

Located in the pump compartment, an electric fuel priming pump eliminates the need for you to manually prime after filter changes. It also eliminates the risk of fuel contamination by preventing unfiltered fuel from being backfilled during filter changes.

## More Service Benefits

Drain tubes beneath the machine make it easy and simple for you to remove water and sediment during routine maintenance. They also make it easy to change oil without special tools or the risk of spilling. Same goes for an integrated fuel level indicator that pops up to help you reduce the possibility of fuel tank overfilling.

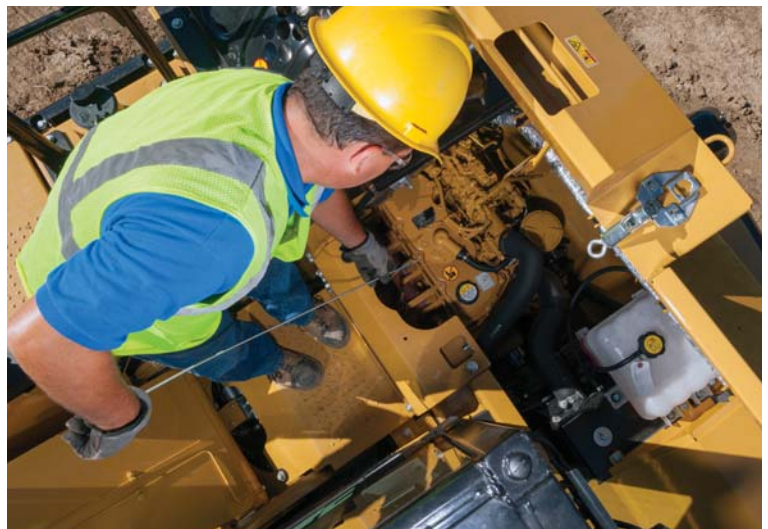
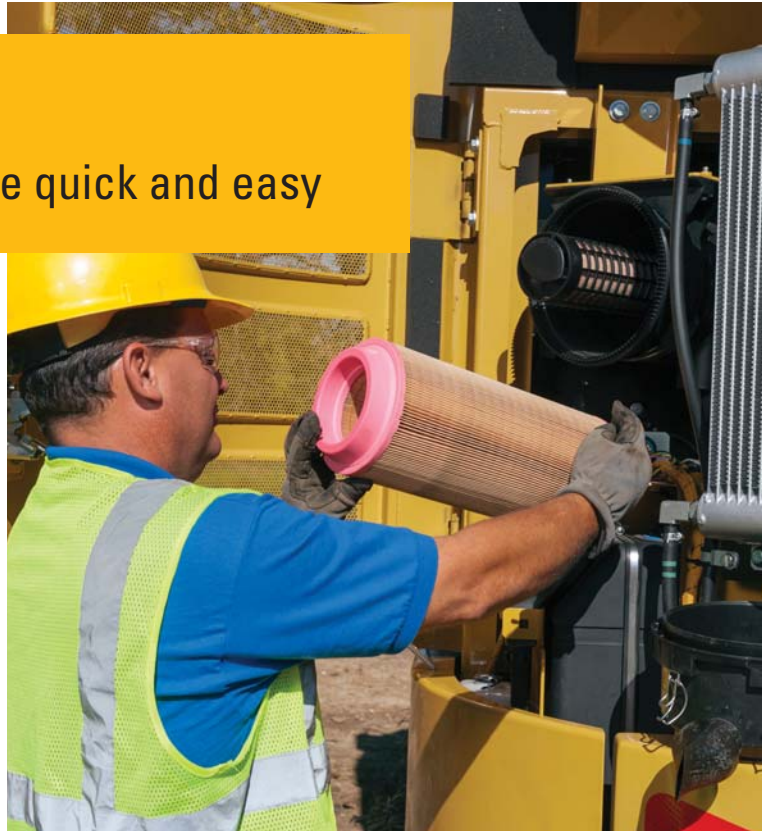

# Safety

## Features to help protect you day in and day out



### Guard Options

The 315F can be equipped with several guarding options. Following are just a few:

- Falling Object Guarding System (FOGS)
- Vandal guards
- Full-length wire mesh
- Heavy-duty bottom guards
- Track guiding guards

### A Safe, Quiet Cab

The roll-over protective structure (ROPS) cab provides you with a safe working environment when properly seated and belted. It also contributes to your comfort because it's attached to a reinforced frame with special viscous mounts that limit vibration and unnecessary sound, and it includes special roof lining and sealing to make it as quiet as any of today's top pickup trucks.

### Secure Contact Points

Multiple large steps get you into the cab as well as a leg up to the compartments. Extended hand and guard rails allow you to safely climb to the upper deck and removable anti-skid plates. Anti-skid plates reduce your slipping hazards in all types of weather conditions.

### Great Views

Ample glass gives you excellent visibility out front and to the side, and the standard rearview camera gives you a clear field of view behind the machine through the cab monitor. The available split-configuration windshield features an upper window with handles that make it easy to slide and store above you and a lower window that can be removed and stored on the inside wall of the cab. The large skylight serves as an emergency exit and provides you with enhanced visibility.

### Smart Lighting

Halogen lights provide plenty of illumination, and the cab and boom lights can be programmed to stay on for up to 90 seconds after the engine's been turned off to help you safely exit the machine.

# Complete Customer Care

Support you can count on



## Expert Advice You Can Trust

What are the job requirements and machine attachments? What production is needed? Your Cat dealer can provide recommendations to help you make the right machine choices.

## Support Agreements To Fit Your Needs

Cat dealers offer a variety of customer support agreements and work with you to develop a plan to meet your specific needs. These plans can cover the entire machine, including attachments, to help protect your investment.

## Parts When & Where You Need Them

Cat dealers utilize a worldwide parts network to maximize your machines' uptime. Plus they can help you save money with Cat remanufactured components.

## Operating Techniques To Boost Your Profits

Improving operating techniques can boost your profits. Your Cat dealer has videos, literature, and other ideas to help you increase productivity. Caterpillar also offers simulators and certified operator training to help maximize the return on your investment.

## Financial Options Just For You

Consider financing options and day-to-day operating costs. Look at dealer services that can be included in the machine's cost to yield lower owning and operating costs over time.

## What's Best For You Today...& Tomorrow

Repair, rebuild, or replace? Your Cat dealer can help you evaluate the cost involved so you can make the best choice for your business.





## Sustainability

Generations ahead in every way

- The C4.4 ACERT engine meets Tier 4 Final emission standards.
- The 315F L has the flexibility of running on either ultra-low-sulfur diesel (ULSD) fuel with 15 ppm of sulfur or less or biodiesel (up to B20) fuel blended with ULSD that meets ASTM 6751 standards.
- An overfill indicator rises when the fuel tank is full to help your service technicians avoid spilling.
- An unique engine oil filter eliminates the need for painted metal cans and aluminum top plates. The cartridge-style spin-on housing enables the internal filter to be separated and replaced; the used internal element can be incinerated to help reduce waste.
- The machine is built to be rebuilt with major structures and components capable of being remanufactured to reduce waste and replacement costs.
- The 315F L is an efficient, productive machine that reduces impact on natural resources for future generations.

# 315F L Hydraulic Excavator Specifications

## Engine

Engine Model	Cat C4.4 ACERT	
Gross Power – SAE J1995	74 kW	100 hp
Net Power – SAE J1349	72 kW	97 hp
Bore	105 mm	4.1 in
Stroke	127 mm	5.0 in
Displacement	4.4 L	270 in <sup>3</sup>

## Weight

Minimum Operating Weight*	15 040 kg	33,160 lb
Maximum Operating Weight**	16 480 kg	36,340 lb
*4.65 m (15'3") reach boom, 2.8 m (9'2") stick, 500 mm (20") shoes, no blade		
**2.13 m (6'11") power offset boom, 2.8 m (9'2") stick, 700 mm (28") shoes, blade		

## Hydraulic System

Main System – Maximum Flow (Total)	256 L/min	68 gal/min
Swing System – Maximum Flow	120 L/min	32 gal/min
Maximum Pressure – Equipment	30 500 kPa	4,420 psi
Maximum Pressure – Power Offset Boom (optional)	29 900 kPa	4,340 psi
Maximum Pressure – Travel	35 000 kPa	5,080 psi
Maximum Pressure – Swing	23 000 kPa	3,340 psi
Pilot System – Maximum Flow	21.9 L/min	4.8 gal/min
Pilot System – Maximum Pressure	4120 kPa	600 psi
Boom Cylinder – Bore	110 mm	4.3 in
Boom Cylinder – Stroke	1000 mm	39.4 in
Stick Cylinder – Bore	120 mm	4.7 in
Stick Cylinder – Stroke	1197 mm	47.1 in
Bucket Cylinder – Bore	100 mm	3.9 in
Bucket Cylinder – Stroke	939 mm	37.0 in

## Drive

Maximum Travel Speed	5.5 km/h	3.4 mph
Maximum Drawbar Pull	113 kN	25,400 lbf

## Swing Mechanism

Swing Speed	11 rpm
Swing Torque	30.9 kN·m 22,790 lbf-ft

## Service Refill Capacities

Fuel Tank Capacity	178 L	47 gal
DEF Tank Capacity	19 L	5 gal
Cooling System	28 L	7.4 gal
Engine Oil (with filter)	13.5 L	3.6 gal
Swing Drive (each)	2.4 L	0.6 gal
Final Drive (each)	3 L	0.8 gal
Hydraulic System (including tank)	160 L	42.3 gal
Hydraulic Tank	84 L	22.2 gal

## Track

Long Undercarriage	
Number of Shoes (each side)	46 pieces
Number of Track Rollers (each side)	7 pieces
Number of Carrier Rollers (each side)	2 pieces

## Sound Performance

ISO 6396	
Operator Noise (Closed)	69 dB(A)
ISO 6395	
Spectator Noise	101 dB(A)

# 315F L Hydraulic Excavator Specifications

## Dimensions

All dimensions are approximate.

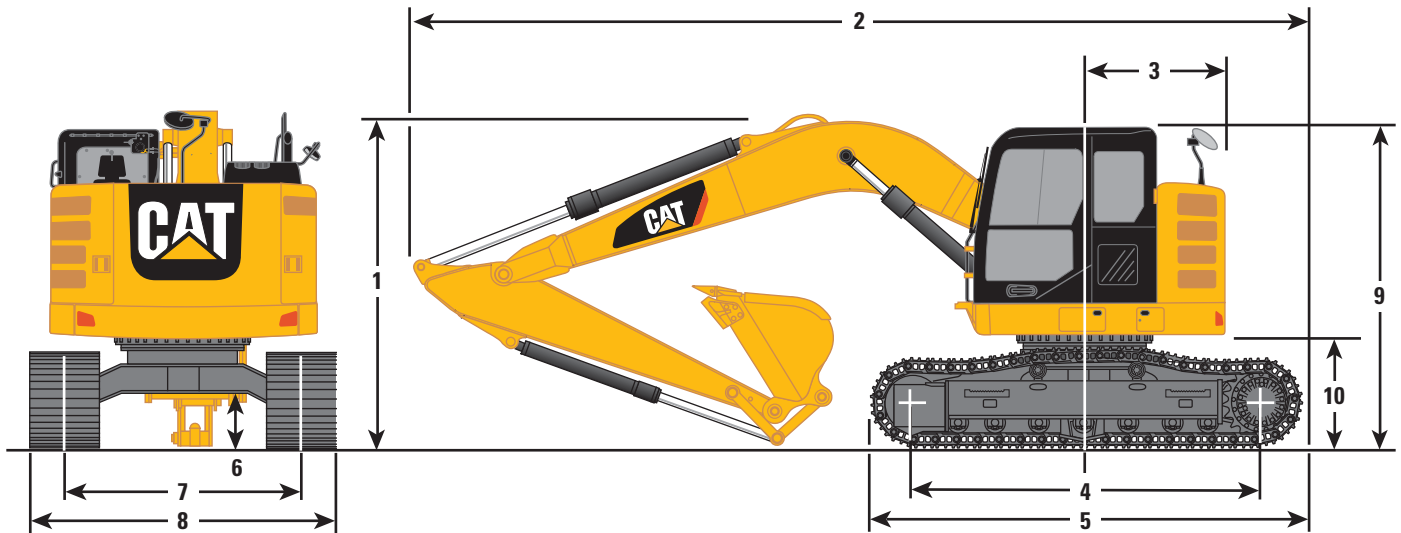

Boom Type	Reach Boom 4.65 m (15'3")				Power Offset Boom	
	R3.0 m (9'10")		R2.8 m (9'2")		2.13 m (6'11")	
<b>Stick Size</b>						
<b>1 Shipping Height*</b>	3000 mm	9'10"	3030 mm	9'11"	3000 mm	9'10"
Shipping Height at Boom Top	2750 mm	9'0"	3030 mm	9'11"	2780 mm	9'1"
Shipping Height with Guard Rail	3000 mm	9'10"	3000 mm	9'10"	3000 mm	9'10"
Shipping Height with Top Guard	2950 mm	9'8"	2950 mm	9'8"	2950 mm	9'8"
<b>2 Shipping Length</b>						
Long Undercarriage	7450 mm	24'5"	7440 mm	24'5"	7560 mm	24'10"
Long Undercarriage with Blade	8010 mm	26'3"	8010 mm	26'3"	8120 mm	26'8"
<b>3 Tail Swing Radius</b>						
Heavy Counterweight	1530 mm	5'0"	1530 mm	5'0"	1530 mm	5'0"
<b>4 Length to Center of Rollers</b>	3040 mm	10'0"	3040 mm	10'0"	3040 mm	10'0"
<b>5 Track Length</b>	3750 mm	12'4"	3750 mm	12'4"	3750 mm	12'4"
<b>6 Ground Clearance</b>	440 mm	1'5"	440 mm	1'5"	440 mm	1'5"
<b>7 Track Gauge</b>	1990 mm	6'6"	1990 mm	6'6"	1990 mm	6'6"
<b>8 Transport Width</b>						
500 mm (20") Shoes	2490 mm	8'2"	2490 mm	8'2"	2490 mm	8'2"
600 mm (24") Shoes	2590 mm	8'6"	2590 mm	8'6"	2590 mm	8'6"
700 mm (28") Shoes	2690 mm	8'10"	2690 mm	8'10"	2690 mm	8'10"
<b>9 Cab Height</b>	2810 mm	9'3"	2810 mm	9'3"	2810 mm	9'3"
Cab Height with Top Guard	2950 mm	9'8"	2950 mm	9'8"	2950 mm	9'8"
<b>10 Counterweight Clearance**</b>	860 mm	2'10"	860 mm	2'10"	860 mm	2'10"

\*Including shoe lug height.

\*\*Without shoe lug height.

All dimensions were calculated with 900 mm (35") wide GD bucket with 0.53 m<sup>3</sup> (0.69 yd<sup>3</sup>) capacity and 1200 mm (3'11") tip radius.

# 315F L Hydraulic Excavator Specifications

## Working Ranges

All dimensions are approximate.

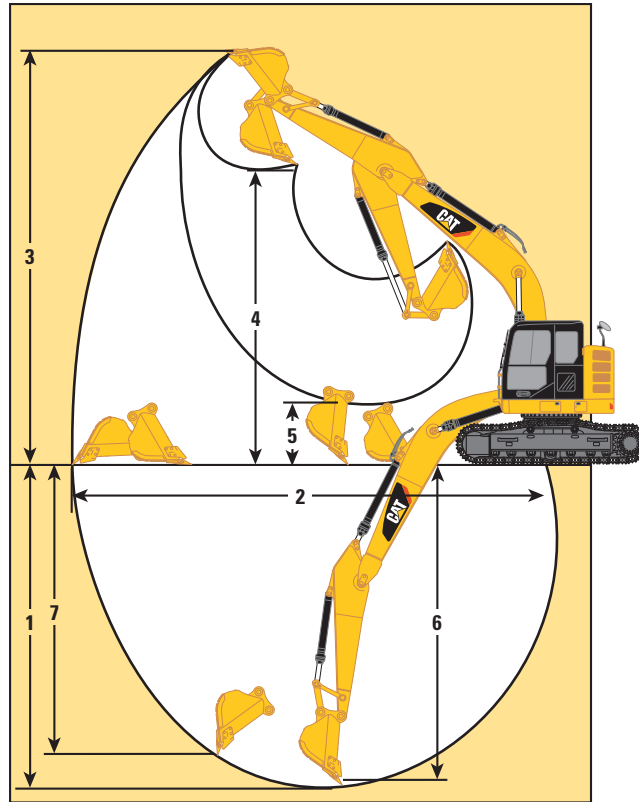

Boom Type	Reach Boom 4.65 m (15'3")			
	R3.0 m (9'10")		R2.8 m (9'2")	
Stick Size				
1 Maximum Digging Depth	5950 mm	19'6"	5750 mm	18'10"
2 Maximum Reach at Ground Level	8680 mm	28'6"	8490 mm	27'10"
3 Maximum Cutting Height	9640 mm	31'8"	9480 mm	31'1"
4 Maximum Loading Height	7190 mm	23'7"	7030 mm	23'1"
5 Minimum Loading Height	2060 mm	6'9"	2240 mm	7'4"
6 Maximum Depth Cut for 2440 mm (8'0") Level Bottom	5660 mm	18'7"	5460 mm	17'11"
7 Maximum Vertical Wall Digging Depth	5280 mm	17'4"	5090 mm	16'8"

All dimensions were calculated with 900 mm (35") wide GD bucket with 0.53 m<sup>3</sup> (0.69 yd<sup>3</sup>) capacity and 1200 mm (3'11") tip radius.

# 315F L Hydraulic Excavator Specifications

## Working Ranges

All dimensions are approximate.

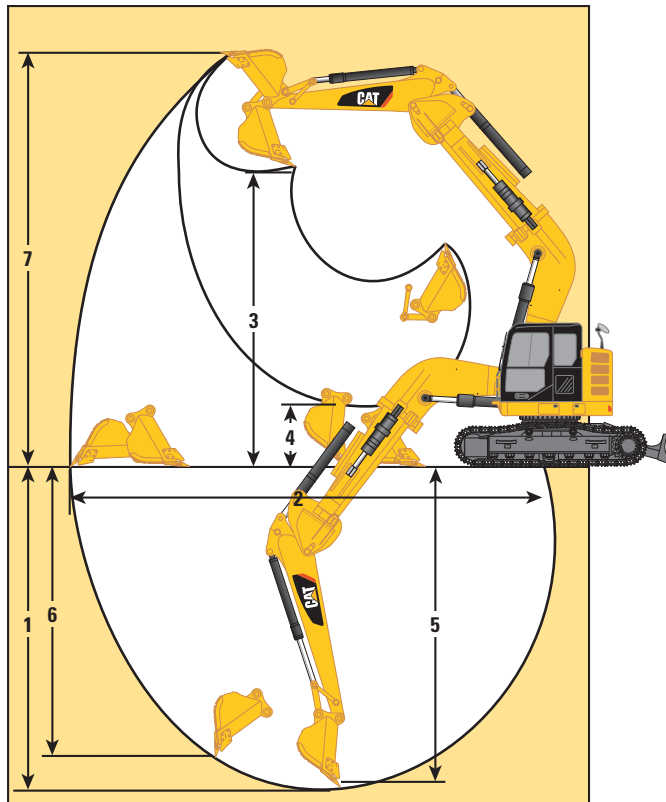

Boom Type Stick Size	Power Offset Boom					
	2.13 m (6'11")*		2.13 m (6'11")		2.13 m (6'11")**	
1 Maximum Digging Depth	4510 mm	14'10"	4840 mm	15'11"	4480 mm	14'8"
2 Maximum Reach at Ground Level	6890 mm	22'7"	7270 mm	23'10"	6850 mm	22'6"
3 Maximum Cutting Height	8110 mm	26'7"	8450 mm	27'9"	8070 mm	26'7"
4 Maximum Loading Height	5680 mm	18'8"	6020 mm	19'9"	5640 mm	18'6"
5 Minimum Loading Height	2330 mm	7'8"	2680 mm	8'10"	2290 mm	7'6"
6 Maximum Depth Cut for 2440 mm (8'0") Level Bottom	4110 mm	13'6"	4450 mm	14'7"	4080 mm	13'5"
7 Maximum Vertical Wall Digging Depth	3270 mm	10'9"	3550 mm	11'8"	3240 mm	10'8"

\*Left side 1100 mm (3'7") offset position

\*\*Right side 1150 mm (3'9") offset position

All dimensions were calculated with 900 mm (35") wide GD bucket with 0.53 m<sup>3</sup> (0.69 yd<sup>3</sup>) capacity and 1200 mm (3'11") tip radius.

# 315F L Hydraulic Excavator Specifications

## Blade Working Ranges

All dimensions are approximate.

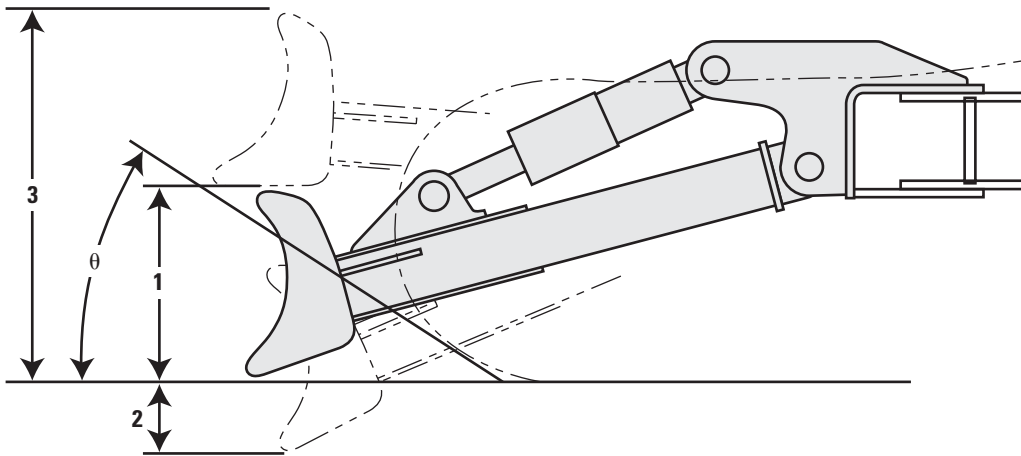

Blade Options	2500 mm (8'2")		2600 mm (8'6")		2700 mm (8'10")	
Recommended Track Shoe Width	500 mm (20")		600 mm (24")		700 mm (28")	
<b>1</b> Blade Height	630 mm	2'1"	630 mm	2'1"	630 mm	2'1"
<b>2</b> Maximum Lowering Depth from Ground	570 mm	1'10"	570 mm	1'10"	570 mm	1'10"
<b>3</b> Maximum Raising Height above Ground	1000 mm	3'3"	1000 mm	3'3"	1000 mm	3'3"
<b>θ</b> Approach Angle	24.9 degrees		24.9 degrees		24.9 degrees	

# 315F L Hydraulic Excavator Specifications

## Major Component Weights

Base Machine	5100 kg	11,250 lb
Long Undercarriage	2660 kg	5,870 lb
Counterweight – 3.56 mt (3.9 t)	3560 kg	7,850 lb
Boom (includes lines, pins and stick cylinder)		
Reach Boom – 4.65 m (15'3")	1040 kg	2,290 lb
Power Offset Boom	1730 kg	3,810 lb
Reach Boom for CGC – 4.65 m (15'3")	1050 kg	2,320 lb
Stick (includes lines, pins, bucket cylinder and bucket linkage)		
R3.0 m (9'10")	650 kg	1,430 lb
R2.8 m (9'2")	620 kg	1,370 lb
2.13 m (6'11") for Power Offset Boom	570 kg	1,260 lb
R3.0 m (9'10") for CGC	650 kg	1,430 lb
R3.0 m (9'10") for Thumb	700 kg	1,540 lb
Track Shoe (Long/per two tracks)		
500 mm (20") Triple Grouser	1570 kg	3,460 lb
500 mm (20") Triple Grouser with Rubber Pad	2080 kg	4,590 lb
600 mm (24") Triple Grouser	1820 kg	4,010 lb
700 mm (28") Triple Grouser	2090 kg	4,610 lb
Blade		
2500 mm (8'2")	810 kg	1,790 lb
2600 mm (8'6")	810 kg	1,790 lb
2700 mm (8'10")	820 kg	1,810 lb

All weights are rounded up to nearest 10 kg and lb. Kg and lb were rounded up separately so some of the kg and lb do not match.

Base machine includes 75 kg (170 lb) operator weight, 90% fuel weight, and undercarriage with center guard.

# 315F L Hydraulic Excavator Specifications

## Operating Weight and Ground Pressure

	700 mm (28") Triple Grouser Shoes				600 mm (24") Triple Grouser Shoes				500 mm (20") Triple Grouser Shoes			
	kg	lb	kPa	psi	kg	lb	kPa	psi	kg	lb	kPa	psi
<b>Long Undercarriage without Blade</b>												
Reach Boom – 4.65 m (15'3")												
R3.0 m (9'10")	15 640	34,486	33.3	4.8	15 370	33,891	38.2	5.5	15 120	33,340	45.1	6.5
R2.8 m (9'2")	15 620	34,442	33.3	4.8	15 350	33,847	38.1	5.5	15 100	33,296	45.0	6.5
<b>Long Undercarriage with Blade</b>												
Reach Boom – 4.65 m (15'3")												
R3.0 m (9'10")	16 480	36,338	35.1	5.1	16 200	35,721	40.3	5.8	15 950	35,170	47.6	6.9
R2.8 m (9'2")	16 460	36,294	35.1	5.1	16 180	35,677	40.2	5.8	15 930	35,126	47.5	6.9
Power Offset Boom												
2.13 m (6'11")	17 140	37,794	36.5	5.3	16 860	37,176	41.9	6.1	16 600	36,603	49.5	7.2

## Bucket and Stick Forces

Boom Type	Reach Boom 4.65 m (15'3")		Power Offset Boom			
	R3.0 m (9'10")	R2.8 m (9'2")	2.13 m (6'11")			
<b>General Duty</b>						
Bucket Digging Force (SAE)	85 kN	19,200 lbf	85 kN	19,200 lbf	78 kN	17,500 lbf
Stick Digging Force (SAE)	57 kN	12,800 lbf	60 kN	13,500 lbf	61 kN	13,700 lbf
<b>Severe Duty</b>						
Bucket Digging Force (SAE)	84 kN	18,800 lbf	83 kN	18,700 lbf	77 kN	17,200 lbf
Stick Digging Force (SAE)	57 kN	12,800 lbf	60 kN	13,400 lbf	61 kN	13,700 lbf









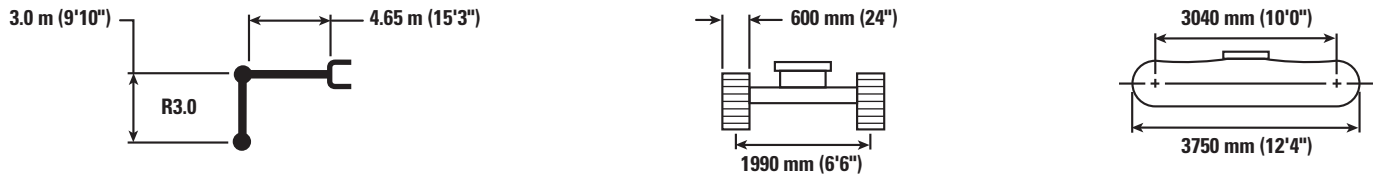

Caterpillar recommends using appropriate work tools to maximize the value customers receive from our products. Use of work tools, including buckets, which are outside of Caterpillar's recommendations or specifications for weight, dimensions, flows, pressures, etc. may result in less-than-optimal performance, including but not limited to reductions in production, stability, reliability, and component durability. Improper use of a work tool resulting in sweeping, prying, twisting and/or catching of heavy loads will reduce the life of the boom and stick.



# 315F L Hydraulic Excavator Specifications

## Reach Boom Lift Capacities – Counterweight: 3.56 mt (3.9 t) – Blade Down



		1.5 m/5.0 ft		3.0 m/10.0 ft		4.5 m/15.0 ft		6.0 m/20.0 ft				
												m ft
7.5 m 25.0 ft	kg lb					*2600 *2600	*2600 *2600			*2500 *5,600	*2500 *5,600	4.54 14.33
6.0 m 20.0 ft	kg lb					*3450 *7,550	*3450 *7,550	*2350 *2350	*2350 *2350	*2100 *4,650	*2100 *4,650	6.07 19.68
4.5 m 15.0 ft	kg lb					*3700 *8,050	*3700 *8,050	*3400 *7,400	3050 6,500	*2000 *4,350	*2000 *4,350	6.96 22.72
3.0 m 10.0 ft	kg lb			*5900 *12,700	*5900 *12,700	*4350 *9,450	*4350 *9,450	*3650 *7,900	2950 6,350	*2000 *4,350	*2000 *4,350	7.43 24.36
1.5 m 5.0 ft	kg lb			*8050 *17,350	7900 16,950	*5150 *11,150	4300 9,200	*3950 *8,550	2850 6,100	*2100 *4,550	2000 4,400	7.58 24.88
0.0 m 0.0 ft	kg lb			*7350 *16,950	*7350 15,950	*5600 *12,100	4050 8,750	*4100 *8,850	2750 5,850	*2300 *5,050	2050 4,450	7.43 24.36
-1.5 m -5.0 ft	kg lb	*4550 *10,150	*4550 *10,150	*8050 *17,450	7300 15,700	*5400 *11,700	3950 8,500	*3900 *8,400	2650 5,750	*2700 *6,000	2200 4,850	6.94 22.73
-3.0 m -10.0 ft	kg lb	*7550 *16,950	*7550 *16,950	*6450 *13,950	*6450 *13,950	*4500 *9,650	3950 8,550	*2950 8,550	2700 5,750	*2850 *6,300	2700 5,950	6.04 19.71
-4.5 m -15.0 ft	kg lb			*3550 *7,350	*3550 *7,350					*2150 *4,500	*2150 *4,500	4.49 14.39



ISO 10567



\*Indicates that the load is limited by hydraulic lifting capacity rather than tipping load. The above loads are in compliance with hydraulic excavator lift capacity standard ISO 10567:2007. They do not exceed 87% of hydraulic lifting capacity or 75% of tipping load. Weight of all lifting accessories must be deducted from the above lifting capacities. Lifting capacities are based on the machine standing on a firm, uniform supporting surface. The use of a work tool attachment point to handle/lift objects, could affect the machine lift performance.









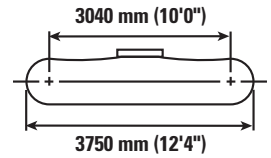
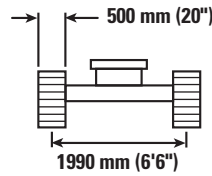
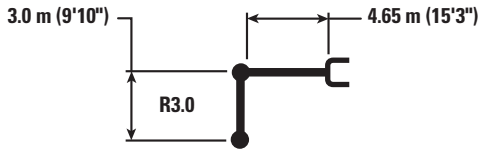

Lift capacity stays with ±5% for all available track shoes.

Always refer to the appropriate Operation and Maintenance Manual for specific product information.

# 315F L Hydraulic Excavator Specifications

## Reach Boom Lift Capacities – Counterweight: 3.56 mt (3.9 t) – Blade Down



		1.5 m/5.0 ft		3.0 m/10.0 ft		4.5 m/15.0 ft		6.0 m/20.0 ft		7.5 m/25.0 ft		 m ft		
														
7.5 m 25.0 ft	kg lb					*2600 *2600						*2500 *5,600	*2500 *5,600	4.54 14.33
6.0 m 20.0 ft	kg lb					*3450 *7,550	*3450 *7,550	*2350 *2350				*2100 *4,650	*2100 *4,650	6.07 19.68
4.5 m 15.0 ft	kg lb					*3700 *8,050	*3700 *8,050	*3400 *7,400	2950 6,300			*2000 *4,350	*2000 *4,350	6.96 22.72
3.0 m 10.0 ft	kg lb			*5900 *12,700	*5900 *12,700	*4350 *9,450	*4350 *9,450	*3650 *7,900	2850 6,100			*2000 *4,350	*2000 *4,350	7.43 24.36
1.5 m 5.0 ft	kg lb			*8050 *17,350	7550 16,250	*5150 *11,150	4100 8,850	*3950 *8,550	2750 5,850	*2500 1950		*2100 *4,550	1950 4,250	7.58 24.88
0.0 m 0.0 ft	kg lb			*7350 *16,950	7100 15,250	*5600 *12,100	3900 8,400	*4100 *8,850	2600 5,650			*2300 *5,050	1950 4,300	7.43 24.36
-1.5 m -5.0 ft	kg lb	*4550 *10,150	*4550 *10,150	*8050 *17,450	7000 15,000	*5400 *11,700	3800 8,150	*3900 *8,400	2550 5,500			*2700 *6,000	2100 4,650	6.94 22.73
-3.0 m -10.0 ft	kg lb	*7550 *16,950	*7550 *16,950	*6450 *13,950	*6450 *13,950	*4500 *9,650	3800 8,200	*2950 *2950	2600 2600			*2850 *6,300	2550 5,700	6.04 19.71
-4.5 m -15.0 ft	kg lb			*3550 *7,350	*3550 *7,350							*2150 *4,500	*2150 *4,500	4.49 14.39



ISO 10567



\*Indicates that the load is limited by hydraulic lifting capacity rather than tipping load. The above loads are in compliance with hydraulic excavator lift capacity standard ISO 10567:2007. They do not exceed 87% of hydraulic lifting capacity or 75% of tipping load. Weight of all lifting accessories must be deducted from the above lifting capacities. Lifting capacities are based on the machine standing on a firm, uniform supporting surface. The use of a work tool attachment point to handle/lift objects, could affect the machine lift performance.









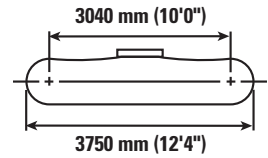
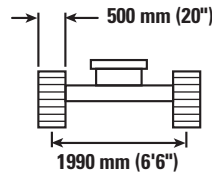
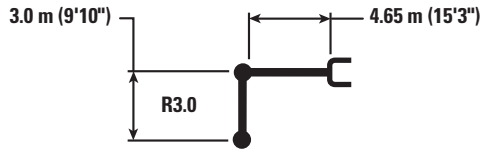

Lift capacity stays with ±5% for all available track shoes.

Always refer to the appropriate Operation and Maintenance Manual for specific product information.

# 315F L Hydraulic Excavator Specifications

## Reach Boom Lift Capacities – Counterweight: 3.56 mt (3.9 t) – Blade Down with Rubber Pad



		1.5 m/5.0 ft		3.0 m/10.0 ft		4.5 m/15.0 ft		6.0 m/20.0 ft		7.5 m/25.0 ft		 m ft		
														
7.5 m	kg					*2600	*2600					*2500	*2500	4.54
25.0 ft	lb											*5,600	*5,600	14.33
6.0 m	kg					*3450	*3450	*2350	*2350			*2100	*2100	6.07
20.0 ft	lb					*7,550	*7,550					*4,650	*4,650	19.68
4.5 m	kg					*3700	*3700	*3400	3000			*2000	*2000	6.96
15.0 ft	lb					*8,050	*8,050	*7,400	6,500			*4,350	*4,350	22.72
3.0 m	kg			*5900	*5900	*4350	*4350	*3650	2950			*2000	*2000	7.43
10.0 ft	lb			*12,700	*12,700	*9,450	*9,450	*7,900	6,300			*4,350	*4,350	24.36
1.5 m	kg			*8050	7800	*5150	4250	*3950	2800	*2500	2050	*2100	2000	7.58
5.0 ft	lb			*17,350	16,750	*11,150	9,150	*8,550	6,050			*4,550	4,400	24.88
0.0 m	kg			*7350	*7350	*5600	4050	*4100	2700			*2300	2000	7.43
0.0 ft	lb			*16,950	15,750	*12,100	8,650	*8,850	5,800			*5,050	4,450	24.36
-1.5 m	kg	*4550	*4550	*8050	7250	*5400	3950	*3900	2650			*2700	2200	6.94
-5.0 ft	lb	*10,150	*10,150	*17,450	15,500	*11,700	8,450	*8,400	5,700			*6,000	4,850	22.73
-3.0 m	kg	*7550	*7550	*6450	*6450	*4500	3950	*2950	2700			*2850	2650	6.04
-10.0 ft	lb	*16,950	*16,950	*13,950	*13,950	*9,650	8,450					*6,300	5,900	19.71
-4.5 m	kg			*3550	*3550							*2150	*2150	4.49
-15.0 ft	lb			*7,350	*7,350							*4,500	*4,500	14.39



ISO 10567



\*Indicates that the load is limited by hydraulic lifting capacity rather than tipping load. The above loads are in compliance with hydraulic excavator lift capacity standard ISO 10567:2007. They do not exceed 87% of hydraulic lifting capacity or 75% of tipping load. Weight of all lifting accessories must be deducted from the above lifting capacities. Lifting capacities are based on the machine standing on a firm, uniform supporting surface. The use of a work tool attachment point to handle/lift objects, could affect the machine lift performance.









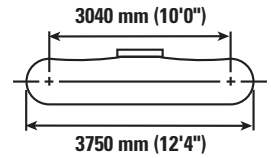
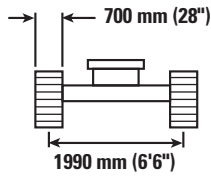
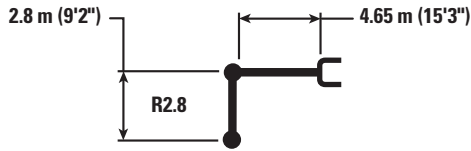

Lift capacity stays with ±5% for all available track shoes.

Always refer to the appropriate Operation and Maintenance Manual for specific product information.

# 315F L Hydraulic Excavator Specifications

## Reach Boom Lift Capacities – Counterweight: 3.56 mt (3.9 t) – Blade Down



		1.5 m/5.0 ft		3.0 m/10.0 ft		4.5 m/15.0 ft		6.0 m/20.0 ft				m ft
												
7.5 m 25.0 ft	kg lb									*2750 *6,200	*2750 *6,200	4.21 13.33
6.0 m 20.0 ft	kg lb					*3650 *7,950	*3650 *7,950			*2300 *5,050	*2300 *5,050	5.84 19.17
4.5 m 15.0 ft	kg lb					*3850 *8,400	*3850 *8,400	*3500 *7,650	3100 6,600	*2150 *4,750	*2150 *4,750	6.75 22.50
3.0 m 10.0 ft	kg lb			*6250 *13,450	*6250 *13,450	*4500 *9,750	*4500 *9,750	*3700 *8,100	3000 6,450	*2150 *4,700	*2150 *4,700	7.24 24.17
1.5 m 5.0 ft	kg lb			*8250 *17,800	7900 16,950	*5250 *11,350	4350 9,300	*4000 *8,650	2900 6,150	*2250 *4,950	2100 4,650	7.40 25.00
0.0 m 0.0 ft	kg lb			*7050 *16,300	*7050 16,050	*5600 *12,100	4100 8,850	*4100 *8,850	2750 5,950	*2500 *5,500	2150 4,700	7.24 24.17
-1.5 m -5.0 ft	kg lb	*4750 *10,600	*4750 *10,600	*7850 *16,950	7400 15,850	*5350 *11,550	4000 8,650	*3850 *8,200	2700 5,850	*3000 *6,600	2350 5,150	6.74 22.50
-3.0 m -10.0 ft	kg lb	*8100 *18,150	*8100 *18,150	*6100 *13,150	*6100 *13,150	*4300 *9,200	4050 8,700			*2900 *6,300	*2900 *6,300	5.81 19.17
-4.5 m -15.0 ft	kg lb									*2500 *2500	*2500 *2500	3.67



ISO 10567



\*Indicates that the load is limited by hydraulic lifting capacity rather than tipping load. The above loads are in compliance with hydraulic excavator lift capacity standard ISO 10567:2007. They do not exceed 87% of hydraulic lifting capacity or 75% of tipping load. Weight of all lifting accessories must be deducted from the above lifting capacities. Lifting capacities are based on the machine standing on a firm, uniform supporting surface. The use of a work tool attachment point to handle/lift objects, could affect the machine lift performance.









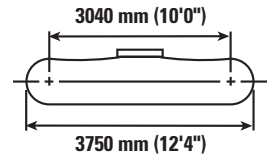
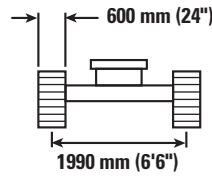
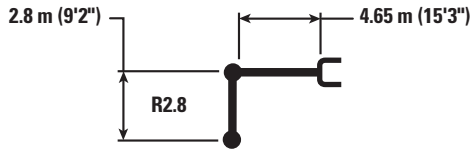

Lift capacity stays with ±5% for all available track shoes.

Always refer to the appropriate Operation and Maintenance Manual for specific product information.

# 315F L Hydraulic Excavator Specifications

## Reach Boom Lift Capacities – Counterweight: 3.56 mt (3.9 t) – Blade Down



		1.5 m/5.0 ft		3.0 m/10.0 ft		4.5 m/15.0 ft		6.0 m/20.0 ft				m ft
												
7.5 m 25.0 ft	kg lb									*2750 *6,250	*2750 *6,250	4.21 13.20
6.0 m 20.0 ft	kg lb					*3650 *7,950	*3650 *7,950			*2300 *5,100	*2300 *5,100	5.83 18.88
4.5 m 15.0 ft	kg lb					*3850 *8,400	*3850 *8,400	*3500 *7,650	3050 6,500	*2150 *4,750	*2150 *4,750	6.75 22.03
3.0 m 10.0 ft	kg lb			*6300 *13,450	*6300 *13,450	*4550 *9,800	*4550 *9,750	*3750 *8,100	2950 6,350	*2150 *4,750	*2150 *4,750	7.24 23.72
1.5 m 5.0 ft	kg lb			*8300 *17,900	7850 16,850	*5300 *11,400	4250 9,200	*4000 *8,700	2850 6,100	*2250 *4,950	2100 4,600	7.39 24.26
0.0 m 0.0 ft	kg lb			*7050 *16,300	*7050 15,950	*5650 *12,200	4050 8,750	*4150 *8,950	2750 5,900	*2500 *5,500	2150 4,650	7.23 23.73
-1.5 m -5.0 ft	kg lb	*4750 *10,600	*4750 *10,600	*7900 *17,100	7350 15,800	*5400 *11,650	4000 8,550	*3850 *8,300	2700 5,800	*3000 *6,600	2350 5,100	6.73 22.05
-3.0 m -10.0 ft	kg lb	*8100 *18,150	*8100 *18,150	*6200 *13,300	*6200 *13,300	*4350 *9,300	4000 8,600			*2900 *6,350	2850 6,350	5.80 18.91
-4.5 m -15.0 ft	kg lb									*2550 *2550	*2550 *2550	3.66



ISO 10567



\*Indicates that the load is limited by hydraulic lifting capacity rather than tipping load. The above loads are in compliance with hydraulic excavator lift capacity standard ISO 10567:2007. They do not exceed 87% of hydraulic lifting capacity or 75% of tipping load. Weight of all lifting accessories must be deducted from the above lifting capacities. Lifting capacities are based on the machine standing on a firm, uniform supporting surface. The use of a work tool attachment point to handle/lift objects, could affect the machine lift performance.









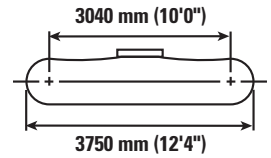
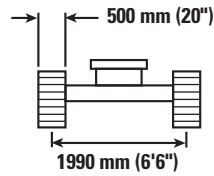
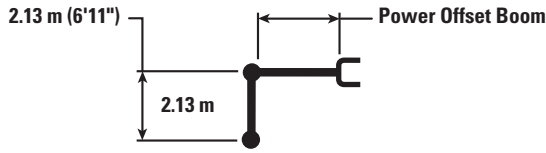

Lift capacity stays with ±5% for all available track shoes.

Always refer to the appropriate Operation and Maintenance Manual for specific product information.

# 315F L Hydraulic Excavator Specifications

## Power Offset Boom Lift Capacities – Counterweight: 3.56 mt (3.9 t) – Blade Down



		1.5 m/5.0 ft		3.0 m/10.0 ft		4.5 m/15.0 ft		6.0 m/20.0 ft				m ft
												
6.0 m 20.0 ft	kg lb			*4550 <b>*10,000</b>	*4550 <b>*10,000</b>					*2750 <b>*6,150</b>	*2750 <b>*6,150</b>	4.21 <b>14.17</b>
4.5 m 15.0 ft	kg lb			*5000 <b>*10,800</b>	*5000 <b>*10,800</b>	*4150 <b>*9,050</b>	*4150 <b>*9,050</b>			*2650 <b>*5,800</b>	*2650 <b>*5,800</b>	5.42 <b>18.33</b>
3.0 m 10.0 ft	kg lb			*6600 <b>*14,200</b>	*6600 <b>*14,200</b>	*4600 <b>*10,000</b>	4450 <b>9,600</b>	*3000	2850	*2750 <b>*6,050</b>	*2750 <b>*6,050</b>	6.02 <b>20.00</b>
1.5 m 5.0 ft	kg lb			*8050 <b>*17,400</b>	7450 <b>16,050</b>	*5150 <b>*11,100</b>	4100 <b>8,850</b>	*3850 <b>*8,350</b>	2700 <b>5,800</b>	*3100 <b>*6,800</b>	2600 <b>5,650</b>	6.21 <b>20.83</b>
0.0 m 0.0 ft	kg lb			*7850 <b>*17,100</b>	7050 <b>15,150</b>	*5250 <b>*11,300</b>	3900 <b>8,350</b>	*3750	2600	*3750 <b>*8,250</b>	2600 <b>5,700</b>	6.01 <b>20.00</b>
-1.5 m -5.0 ft	kg lb	*6300 <b>*14,050</b>	*6300 <b>*14,050</b>	*6700 <b>*14,450</b>	*6700 <b>*14,450</b>	*4650 <b>*10,050</b>	3800 <b>8,200</b>			*3700 <b>*8,100</b>	3000 <b>6,550</b>	5.40 <b>18.33</b>
-3.0 m -10.0 ft	kg lb			*4450 <b>*9,450</b>	*4450 <b>*9,450</b>					*3300 <b>*7,150</b>	*3300 <b>*7,150</b>	4.17 <b>14.17</b>



ISO 10567



\*Indicates that the load is limited by hydraulic lifting capacity rather than tipping load. The above loads are in compliance with hydraulic excavator lift capacity standard ISO 10567:2007. They do not exceed 87% of hydraulic lifting capacity or 75% of tipping load. Weight of all lifting accessories must be deducted from the above lifting capacities. Lifting capacities are based on the machine standing on a firm, uniform supporting surface. The use of a work tool attachment point to handle/lift objects, could affect the machine lift performance.

Lift capacity stays with ±5% for all available track shoes.

Always refer to the appropriate Operation and Maintenance Manual for specific product information.

# 315F L Hydraulic Excavator Specifications

## Work Tool Offering Guide\*

Boom Type	Reach Boom	
	R3.0 m (9'10")	R2.8 m (9'2")
Hydraulic Hammer	H110Es H115Es	H110Es H115Es
Mobile Scrap and Demolition Shear	S320B**	S320B**
Compactor (Vibratory Plate)	CVP75	CVP75
Contractors' Grapple	G112B	G112B
Trash Grapple		
Thumbs	These work tools are available for the 315F L. Consult your Cat dealer for proper match.	
Rakes		
Cat Pin Grabber Coupler		

\*Matches are dependent on excavator configurations. Consult your Cat dealer for proper work tool match.

\*\*Boom Mount.

# 315F L Hydraulic Excavator Specifications

## Bucket Specifications and Compatibility

	Width		Capacity		Weight		Fill	Reach Booms			POB**
	mm	in	m <sup>3</sup>	yd <sup>3</sup>	kg	lb		%	R3.0 m (9'10")	R2.8 m (9'2")	
<b>Without Quick Coupler</b>											
General Duty (GD)	450	18	0.20	0.27	276	608	100	●	●	●	●
	600	24	0.31	0.40	326	719	100	●	●	●	●
	750	30	0.41	0.54	374	823	100	●	●	●	●
	900	36	0.53	0.69	423	932	100	●	●	●	●
	1050	42	0.65	0.84	469	1,034	100	⊙	⊙	⊖	X
	1200	48	0.76	1.00	510	1,125	100	X	X	X	X
Severe Duty (SD)	600	24	0.31	0.40	367	810	90	●	●	●	●
	750	30	0.41	0.54	425	936	90	●	●	●	●
	900	36	0.53	0.69	483	1,065	90	●	●	●	●
	1050	42	0.65	0.84	529	1,166	90	⊙	●	⊖	X
Maximum load pin-on (payload + bucket)							kg	1605	1690	1555	2275
							lb	3,537	3,725	3,427	5,014

The above loads are in compliance with hydraulic excavator standard EN474, they do not exceed 87% of hydraulic lifting capacity or 75% of tipping capacity with front linkage fully extended at ground line with bucket curled.

Capacity based on ISO 7451.

Bucket weight with Long tips.

\*Densities with 3.0 m (9'10") thumb stick do not consider thumb weight.

\*\*POB installs blade as standard configuration.

### Maximum Material Density:

- 2100 kg/m<sup>3</sup> (3,500 lb/yd<sup>3</sup>)
- ⊙ 1800 kg/m<sup>3</sup> (3,000 lb/yd<sup>3</sup>)
- ⊖ 1500 kg/m<sup>3</sup> (2,500 lb/yd<sup>3</sup>)
- X Not recommended

Caterpillar recommends using appropriate work tools to maximize the value customers receive from our products. Use of work tools, including buckets, which are outside of Caterpillar's recommendations or specifications for weight, dimensions, flows, pressures, etc. may result in less-than-optimal performance, including but not limited to reductions in production, stability, reliability, and component durability. Improper use of a work tool resulting in sweeping, prying, twisting and/or catching of heavy loads will reduce the life of the boom and stick.



# 315F L Hydraulic Excavator Specifications

## Bucket Specifications and Compatibility

	Width		Capacity		Weight		Fill	Reach Booms			POB**
	mm	in	m <sup>3</sup>	yd <sup>3</sup>	kg	lb		%	R3.0 m (9'10")	R2.8 m (9'2")	
<b>With Quick Coupler</b>											
General Duty (GD)	450	18	0.20	0.27	276	608	100	●	●	●	●
	600	24	0.31	0.40	326	719	100	●	●	●	●
	750	30	0.41	0.54	374	823	100	●	●	●	●
	900	36	0.53	0.69	423	932	100	⊙	⊙	⊖	●
	1050	42	0.65	0.84	469	1,034	100	○	⊖	○	●
	1200	48	0.76	1.00	510	1,125	100	◇	○	◇	⊙
Severe Duty (SD)	600	24	0.31	0.40	367	810	90	●	●	●	●
	750	30	0.41	0.54	425	936	90	●	●	●	●
	900	36	0.53	0.69	483	1,065	90	⊙	●	○	●
	1050	42	0.65	0.84	529	1,166	90	⊖	⊖	○	●
Maximum load with coupler (payload + bucket)							kg	1359	1444	1309	2029
							lb	2,996	3,183	2,885	4,472

The above loads are in compliance with hydraulic excavator standard EN474, they do not exceed 87% of hydraulic lifting capacity or 75% of tipping capacity with front linkage fully extended at ground line with bucket curled.

Capacity based on ISO 7451.

Bucket weight with Long tips.

\*Densities with 3.0 m (9'10") thumb stick do not consider thumb weight.

\*\*POB installs blade as standard configuration.

### Maximum Material Density:

- 2100 kg/m<sup>3</sup> (3,500 lb/yd<sup>3</sup>)
- ⊙ 1800 kg/m<sup>3</sup> (3,000 lb/yd<sup>3</sup>)
- ⊖ 1500 kg/m<sup>3</sup> (2,500 lb/yd<sup>3</sup>)
- 1200 kg/m<sup>3</sup> (2,000 lb/yd<sup>3</sup>)
- ◇ 900 kg/m<sup>3</sup> (1,500 lb/yd<sup>3</sup>)

Caterpillar recommends using appropriate work tools to maximize the value customers receive from our products. Use of work tools, including buckets, which are outside of Caterpillar's recommendations or specifications for weight, dimensions, flows, pressures, etc. may result in less-than-optimal performance, including but not limited to reductions in production, stability, reliability, and component durability. Improper use of a work tool resulting in sweeping, prying, twisting and/or catching of heavy loads will reduce the life of the boom and stick.

# 315F L Standard Equipment

## Standard Equipment

Standard equipment may vary. Consult your Cat dealer for details.

### CAB

- Pressurized operator station with positive filtration
- Sliding upper door window (left-hand cab door)
- Removable lower windshield with in cab storage bracket
- Coat hook
- Beverage holder
- Literature holder
- AM/FM radio
- Radio with MP3 auxiliary audio port
- Two stereo speakers
- Storage shelf suitable for lunch or toolbox
- Color LCD display with indicators, filter/fluid change, and working hour information
- Adjustable armrest
- Height adjustable joystick consoles
- Neutral lever (lock out) for all controls
- Travel control pedals with removable hand levers
- Capability of installing additional pedal
- Power outlets, 5 amp
- Travel alarm
- Laminated glass front upper window and tempered other windows

### ELECTRICAL

- 80 amp alternator
- Circuit breaker
- Capability to electrically connect a beacon

### ENGINE

- C4.4 ACERT diesel engine
- Biodiesel capable
- Meets Tier 4 Final emission standards
- 2300 m (7,500 ft) altitude capability
- Electric priming pump
- Automatic engine speed control
- Economy and high power modes
- Two-speed travel
- Side-by-side cooling system
- Radial seal air filter
- Primary filter with water separator and water separator indicator
- Secondary filter
- Screen filter in fuel line
- Variable speed fan with viscous clutch

### HYDRAULIC SYSTEM

- Boom drift reduction valve
- Regeneration circuit for boom and stick
- Reverse swing dampening valve
- Automatic swing parking brake
- High-performance hydraulic return filter
- Fine swing control

### LIGHTS

- Halogen boom light (left side)
- Time delay function for boom light and cab light
- Exterior light

### UNDERCARRIAGE

- Center track guiding guard
- Grease Lubricated Track GLT2, resin seal
- Towing eye on base frame

### SECURITY

- Cat one key security system
- Door locks
- Cap locks on fuel and hydraulic tanks
- Lockable external tool/storage box
- Signaling/warning horn
- Secondary engine shutoff switch
- Rear window for emergency exit
- Guard, travel motor protection
- Guard rail
- Rearview camera

### TECHNOLOGY

- Product Link

## Optional Equipment

Optional equipment may vary. Consult your Cat dealer for details.

### CAB

- Seat, high-back air suspension with heater and cooling
- Seat, high-back air suspension with heater
- Seat, high-back mechanical suspension
- Right pedal
- Rain protector
- Cab mirror
- Ashtray

### COUNTERWEIGHT

- 3.56 mt (3.9 t) without lifting eye

### ELECTRICAL

- Cold weather battery  $-25^{\circ}\text{C}$  ( $-13^{\circ}\text{F}$ )
- Jump start receptacle

### ENGINE

- Quick drains, engine and hydraulic oil

### FRONT LINKAGE

- Quick coupler
- Bucket linkage
- 4.65 m (15'3") Reach Boom
- Power Offset Boom
- 2.13 m (6'11") stick for Power Offset Boom
- 2.8 m (9'2") stick
- 3.0 m (9'10") stick
- 3.0 m (9'10") thumb-ready stick

### HYDRAULIC SYSTEM

- Control pattern quick-changer, two way
- Auxiliary hydraulics
- Boom and stick lines
- High-pressure line
- Medium-pressure line
- Quick coupler line
- Boom lowering and stick lowering control device
- Cat Bio hydraulic oil

### LIGHTS

- Working light, cab mounted with time delay
- HID light, cab mounted with time delay
- Halogen boom lights (right side)

### UNDERCARRIAGE

- 500 mm (20") triple grouser shoes
- 600 mm (24") triple grouser shoes
- 700 mm (28") triple grouser shoes
- Rubber pad for 500 mm (20") triple grouser shoes
- 2500 mm (8'2") blade with replaceable cutting edge
- 2600 mm (8'6") blade with replaceable cutting edge
- 2700 mm (8'10") blade with replaceable cutting edge
- Swivel guard

### SECURITY

- FOGS, bolt-on
- Guard, cab front, mesh
- Guard, vandalism
- Security system fitted (MSS)
- Bottom guards, heavy duty
- Rearview camera

### TECHNOLOGY

- Cat Grade Control Depth and Slope

For more complete information on Cat products, dealer services, and industry solutions, visit us on the web at [www.cat.com](http://www.cat.com)

AEHQ7728 (02-2016)  
(NACD)

© 2016 Caterpillar  
All rights reserved

Materials and specifications are subject to change without notice. Featured machines in photos may include additional equipment. See your Cat dealer for available options.

CAT, CATERPILLAR, SAFETY.CAT.COM, their respective logos, "Caterpillar Yellow" and the "Power Edge" trade dress, as well as corporate and product identity used herein, are trademarks of Caterpillar and may not be used without permission.

VisionLink is a trademark of Trimble Navigation Limited, registered in the United States and in other countries.

