

# 320F L

Hydraulic Excavator



## Engine

Engine Model	Cat® C4.4 ACERT™	
Engine Power – ISO 14396	122 kW	164 hp
Net Power – SAE J1349	120 kW	161 hp

## Drive

Maximum Travel Speed – High	5.6 km/h	3.5 mph
Maximum Drawbar Pull	205 kN	46,086 lb

## Weights

Operating Weight	22 300 kg	49,200 lb
------------------	-----------	-----------

## Key Performance Statistics & Facts

### Maximum Lift without Limitation\*

11 500 kg (24,900 lb) without bucket

\*Ground level, 4500 mm (15') out front

### Maximum Reach

9860 mm (32'4")

### Maximum Dig Depth

6720 mm (22'1")

### Maximum Bucket Size

1.59 m<sup>3</sup> (2.08 yd<sup>3</sup>) 1350 mm (54")

## Contents

Hydraulics .....	4
Engine .....	6
Integrated Technologies .....	7
Operator Station .....	8
Front Linkage .....	10
Structures & Undercarriage .....	11
Attachments .....	12
Serviceability .....	14
Safety .....	16
Complete Customer Care .....	17
Sustainability .....	18
Specifications .....	19
Standard Equipment .....	28
Optional Equipment .....	29
Notes .....	30





**The new Cat 320F L is built for those who need strong, reliable performance at a low cost per hour. The machine features an efficient C4.4 ACERT engine that's light on fuel. It also has a proven hydraulic system that will help you take on a variety of tasks.**

**Unlike other brands in its size class, the machine comes equipped with more unique attributes: Robust structures, strong and stable undercarriage, a quiet and comfortable roll-over protective structure (ROPS) cab, and easy-to-reach service points are just a few.**

**Bottom line: If you are looking for a reliable, durable, low-cost-per-hour excavator to get your work done – backed by unmatched support from a brand you can trust – look no further than the 320F L. It simply makes a great deal of business sense.**

# Hydraulics

Power to move your material with speed, ease, and precision

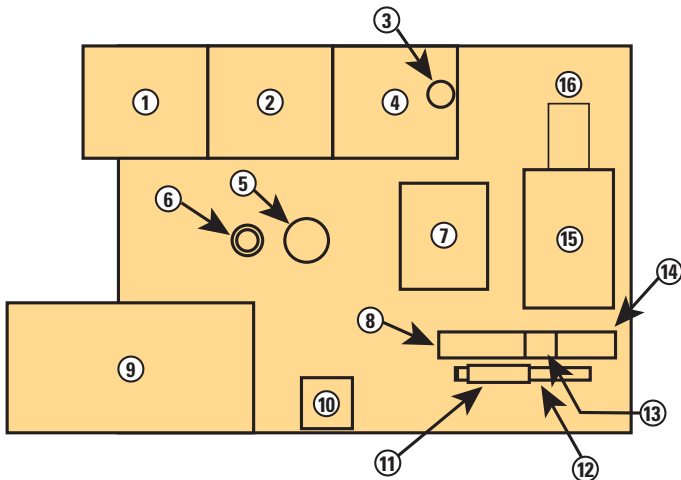

- |                             |                       |                     |
|-----------------------------|-----------------------|---------------------|
| 1) Storage Box and DEF Tank | 6) Swivel Joint       | 12) A/C Condenser   |
| 2) Fuel Tank                | 7) Main Control Valve | 13) Air Aftercooler |
| 3) Capsule Filter           | 8) Oil Cooler         | 14) Radiator        |
| 4) Hydraulic Tank           | 9) Cab                | 15) Engine          |
| 5) Swing Motor              | 10) Battery           | 16) Pumps           |
|                             | 11) Fuel Cooler       |                     |

## A Logical Layout

All major hydraulic components are strategically located close together. This positioning leads to reduced friction loss and pressure drops, and the result is more hydraulic horsepower for the heavy-lifting, ground-breaking work you need to get done.

## A Forceful, Responsive Design

The 320F L features a negative flow control hydraulic system. In layman's terms, negative flow control *decreases* pump flow when oil pressure *increases* and vice versa. The net result is the pump and valve operate in harmony with less energy *and* less wear and tear.

## Valves For Added Efficiency

The 320F L is built with a back-to-back main control valve, and the benefit to you is reduced pressure loss and fuel consumption due to the shorter distance oil has to travel. The machine also features special boom and stick valves that recirculate oil flow in the cylinders during work instead of going all the way back to the tank. The valves contribute to energy savings, but their primary benefit is allowing more oil to flow to other functions so you can experience faster cycle times and more production.

## Tool Control For Enhanced Performance

Tool control is a distinct Cat excavator advantage that adds incredible convenience and enhanced performance to your everyday work. The electronic system stores flows and pressures for up to 20 work tools right in the cab monitor, eliminating the need to calibrate tools every time you make a change out front. It works with both one- and two-way-flow tools, and it can be outfitted with a third pump and medium-pressure circuit so you can use tools like shears, grapples, and tilt buckets. Standard high-pressure circuits make the tools open and close; medium-pressure circuits enable them to rotate. Adding an optional quick coupler circuit makes tool changes even faster for maximum productivity.



## Other Cat Exclusive Hydraulic System Advantages



The capsule filter (1) is designed to take out impurities and help you avoid system contamination and accidental spilling. The self-contained, maintenance-friendly filter is easy to remove with a simple wrench. It can take out impurities as small as beta 10 – particles so tiny you cannot see them with the eye. A sensor lets you know if there is a clog or if pressure exceeds a certain level so you can take action.

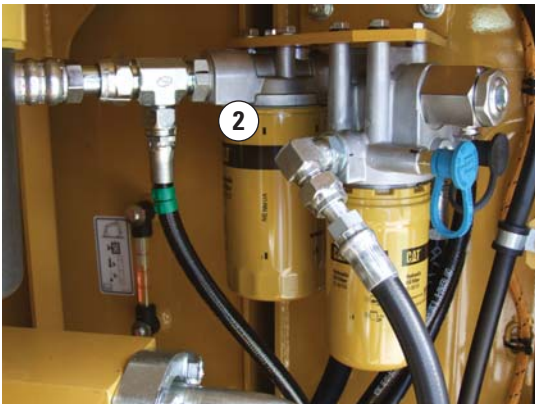

The drain filter (2) is one extra level of contamination prevention Cat excavators offer. Located in the pump compartment behind the pilot filter, the drain filter purifies the case drain from the main pumps, swing motor, and travel motors – all to enhance the life of the pumps and motors and increase uptime for you.



# Engine

Powerful and fuel efficient to meet your expectations

## Proven Technology

Every U.S. EPA Tier 4 Final ACERT engine is equipped with a combination of proven electronic, fuel, air, and aftertreatment components. Applying these time-tested technologies lets us meet your high expectations for productivity, fuel efficiency, reliability, and service life.

Following are the results you can expect:

- **Improved fluid efficiency of up to 5%** over Tier 4 Interim products, including Diesel Exhaust Fluid (DEF) consumption.
- **High performance** across a variety of applications.
- **Enhanced reliability** through commonality and simplicity of design.
- **Maximized uptime and reduced cost** with world-class Cat dealer support.
- **Minimized impact** on emission systems – with no operator interaction required.
- **Durability** with long service life.
- **Better fuel economy** with minimized maintenance costs.
- **Same great power** and response.

## Less Fuel, Same Power

The 320F L consumes up to 8.5% less fuel than a same-size Tier 4 Interim machine with no loss in power. How's that possible? Simple. Advanced engine technology and system control. Isochronous control, for example, permits the engine to run at a constant lower speed but at an optimum point in the power curve for maximum efficiency. Automatic engine speed control also contributes by lowering rpm when the machine isn't calling for it. Plus you have a choice of two power modes – standard and eco mode. Simply change between modes through the switch panel to meet the work needs in front of you. Collectively, all of these benefits add up to reduced fuel consumption, reduced repair and maintenance costs, and increased engine life for you.

## Biodiesel Not A Problem

The C4.4 ACERT engine can run on up to B20 biodiesel that meets ASTM 6751 standards – all to give you more potential fuel-saving flexibility.

# Integrated Technologies

Monitor, manage, and enhance your  
job site operations



## Cat Connect

The smart use of technology and services will improve your job site efficiency. In fact, using data from technology-equipped machines give you more information and insight into your equipment and operations than ever before.

## LINK Technologies

LINK technologies like Product Link™ wirelessly connect you to your equipment, giving you valuable insight into how your machine or fleet is performing. The system comes as standard equipment on the 320F, and it tracks location, hours, fuel usage, productivity, idle time, and diagnostic codes through the online VisionLink® interface so you can make timely, fact-based decisions to maximize efficiency, improve productivity, and lower operating costs.





## Operator Station

Comfort and convenience to keep you productive

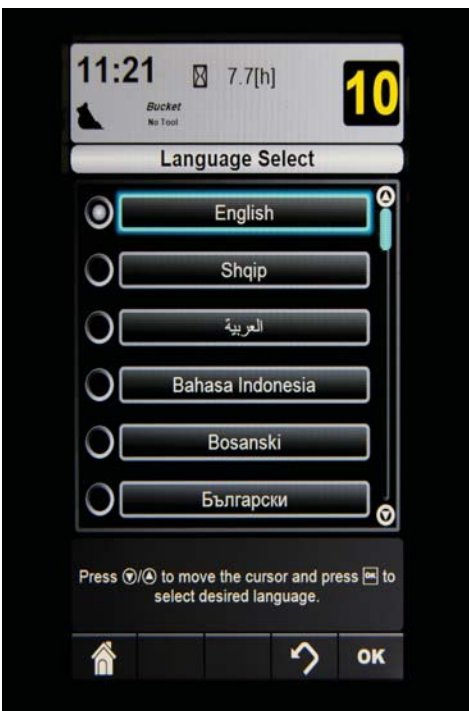

### A Helpful Monitor

The LCD monitor is easy to see and navigate. Programmable in up to 44 languages to meet today's diverse workforce, the monitor clearly displays critical information you need to operate efficiently and effectively. Plus it projects the image from the standard rearview camera to help you see what's going on around you so you can stay safely focused on the job at hand.



### **A Safe, Quiet Cab**

The ROPS cab provides you with a safe working environment. It also contributes to your comfort because it's attached to a reinforced frame with special viscous mounts that limit vibration and unnecessary sound. Add in special roof lining and sealing and you have a cab that's as quiet inside as today's top pickup trucks.



### **Comfortable Seat**

An air suspension seat comes standard on the 320F. The seat features a reclining back, upper and lower slide adjustments, and height and tilt angle adjustments to meet your needs for maximum comfort.

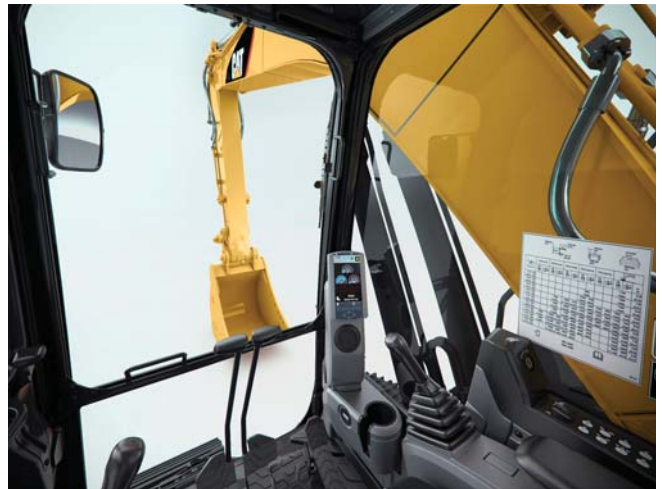

### **A Cool & Warm Environment**

The automatic climate control system features multiple air outlets with filtered ventilation. Air flows on the floor, behind the seat, and in front of you to make your work in either hot or cold weather much more pleasant and productive.

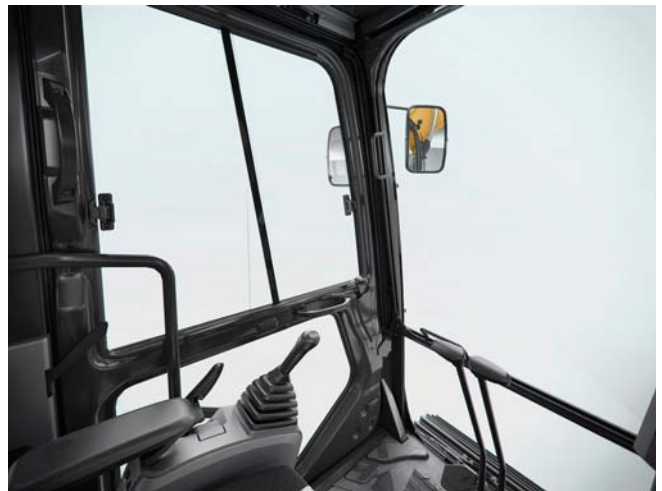

### **Controls Just For You**

The joystick consoles adjust to improve your comfort and productivity during the course of a day. The armrests telescope up and down just like a bicycle seat. Joysticks for tool control have buttons to make working with a two-way-flow grapple, thumb, and shear simple. The right joystick features a button that will reduce engine speed when you are not working to help save fuel. Touch it once and speed reduces; touch it again and speed increases for normal operation.



### **Ample Storage & Auxiliary Power**

Storage spaces are located in the front, rear, and side consoles of the cab. A drink holder accommodates a large mug, and a shelf behind the seat stores large lunch or toolboxes. Two 12-volt power supply sockets are conveniently located near the key storage areas for charging your electronic devices like an MP3 player, a cell phone, or a tablet.

# Front Linkage

Options to take on your far-reaching and up-close tasks



## Link & Pins

The power link between the stick and bucket is designed for long-term heavy-duty lifting. With an integrated lifting eye, the power link helps enhance the machine's lifting capability by lowering your load point and maximizing the power built into the boom cylinders. All pins used in the front linkage have thick chrome plating to give them high wear and corrosion resistance. The large diameter pins distribute load weight to ensure long pin, boom, and stick life.

## Boom & Stick

The 320F is offered with a reach boom and stick. This combination allows for excellent all-around versatility. Your Cat dealer can help you equip the machine with the right attachments for your specific line of work.

## Built To Last

The boom and stick are built with internal baffle plates for additional durability, and they undergo ultrasound inspection to ensure quality and reliability. Large box-section structures with thick, multi-plate fabrications, castings, and forgings are used in high-stress areas such as the boom nose, boom foot, and boom and stick cylinders to enhance durability for the tough work you do.

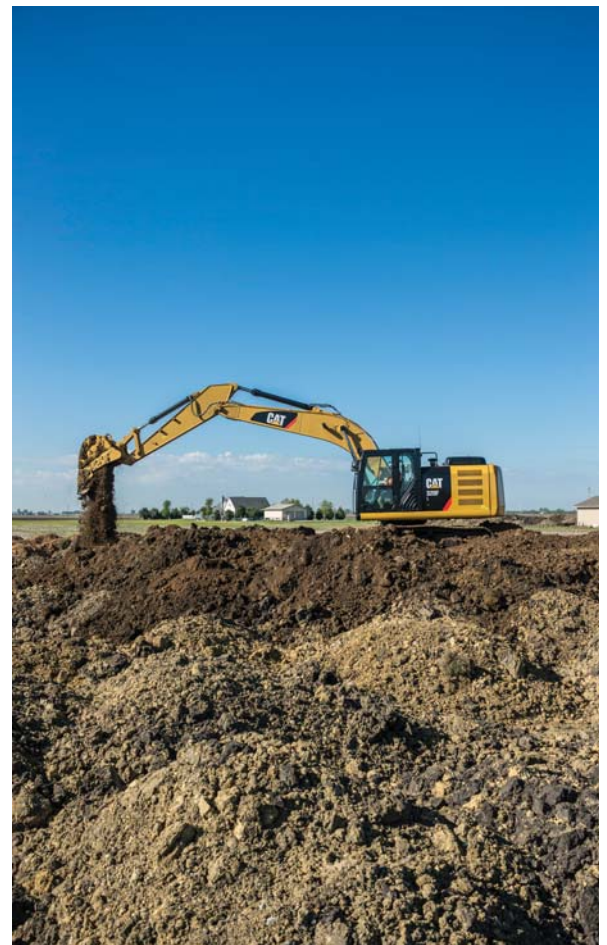



# Structures & Undercarriage

Made to work in your demanding applications

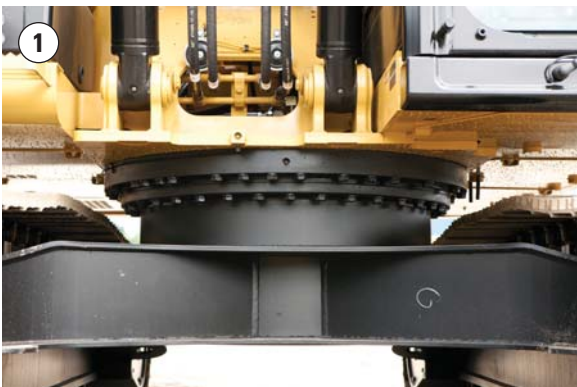

## Robust Frame

The 320F L is a well-built machine designed to give you a very long service life. The upper frame (1) has mountings made specifically to support the heavy-duty cab; it's also reinforced around key areas that take on stress like the boom foot and skirt. Massive bolts are used to attach the track frames to the body, and additional bolts are used throughout to increase the machine's digging force, which leads to more productivity for you.



## Durable Undercarriage

The long undercarriage (2) contributes significantly to the 320F's outstanding stability and durability. Track shoes, links, rollers, idlers, and final drives are all built with long-lasting, high-tensile-strength steel. Cat Grease Lubricated Track 2 (GLT2) track link protects moving parts by keeping water, debris, and dust out and grease sealed in, which delivers longer wear life and reduced noise when traveling. Optional guide guards help maintain track alignment to improve the machine's overall performance – whether you're traveling on a flat, heavy bed of rock or a steep, wet field of mud.



## Huge Counterweight

The counterweight (3) weighs nearly 3700 kg (8,000 lb) to help enhance lift capability – out front and over the side. Rounded to minimize the amount of overhang, the weight is bolted directly to the main frame using four massive bolts to ensure maximum rigidity. Plus the counterweight has an integrated housing to help protect the machine's standard rearview camera.

# Attachments

Tools to make you productive and profitable



## Get The Most Out Of One Machine

You can easily expand the performance of your machine by utilizing any of the variety of attachments offered by Cat Work Tools.

## Change Jobs Quickly

A quick coupler brings the ability to quickly change attachments and switch from job to job. The Cat Pin Grabber coupler is the secure way to decrease downtime and increase job site flexibility and overall productivity.

## Dig, Rip, Finish & Compact

Cat buckets dig everything from top soil to harsh, abrasive material. Add a ripper to get through hard rock. For finishing and grading work, compact and shallow ditch cleaning buckets fit the need. A Cat compactor prepares the area for the next phase of construction.

## Break, Demolish, Scrap, Move & Handle

A hydraulic hammer equips your machine for breaking rock in quarries, preparing trenches on construction sites, or taking down bridge pillars and reinforced concrete on road jobs. Multi-processor, pulverizer, and shear attachments take your machine into structure demolition jobs and process the debris for reuse and recycle. Add a thumb to move and handle brush, rocks, and debris. For constant material handling, a grapple is your solution. Choose from three different styles for picking, sorting, and loading trash, demolition debris, or recyclables.

## Set Up Your Machine For Profitability

Your Cat dealer can install hydraulic kits to properly operate all Cat Work Tool attachments – maximizing the machine's uptime and your profits. All Cat Work Tool attachments are supported by the same Cat dealer network as your Cat machine.

**SWAP TOOLS**



**Pin Grabber Coupler**

**GRAB, SORT, LOAD**



**Contractors' Grapples**



**Demolition & Sorting Grapples**



**Pro Series Thumbs**



**Stiff Link Thumbs**



**Utility Thumbs**



**Trash Grapples**

**DIG & PACK**



**Ditch Cleaning and Tilt Buckets**



**General Duty Buckets**



**Heavy Duty Buckets**



**Severe Duty Buckets**



**Vibratory Plate Compactors**

**CUT, CRUSH, BREAK & RIP**



**Multi-Processors**



**Scrap & Demolition Shears**



**Secondary Pulverizers**



**Hydraulic Hammers**



**Rippers**



# Serviceability

Designed to make your maintenance quick and easy



## On-Board Monitoring

The 320F has a pre-start monitoring system that allows you to check coolant, hydraulic oil, and engine oil levels right inside the cab. The monitor also tells you fluid and filter change intervals to ensure you keep the machine in top-performing condition.

### Safe, Convenient Access

You can see the service hour meter inside the cab and reach most routine maintenance items like fluid taps and grease points from the safety and convenience of ground level. Filters are banked together for higher service efficiency. Compartments feature wide service doors and heavy-duty hardware to keep them open – all to make service work simpler and more secure.

### A Fresh Idea

The fresh air filter is conveniently located on the side of the cab to make it easy for you to reach and replace. It's protected by a lockable door that can only be opened with the engine key.

### A Priming Solution

Located in the pump compartment, an electric fuel priming pump eliminates the need for you to manually prime after filter changes. It also eliminates the risk of fuel contamination by preventing unfiltered fuel from being backfilled during filter changes.

### More Service Benefits

Drain tubes beneath the machine make it easy and simple for you to remove water and sediment during routine maintenance. They also make it easy to change oil without special tools or the risk of spilling. Same goes for an integrated fuel level indicator that pops up to help you reduce the possibility of fuel tank overfilling.

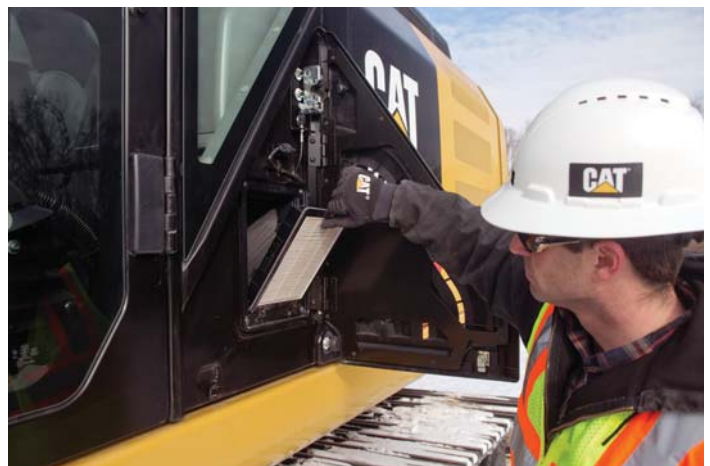

# Safety

Features to help protect you day in and day out

## A Safe, Quiet Cab

The ROPS cab provides you with a safe working environment when properly seated and belted. It also contributes to your comfort because it's attached to a reinforced frame with special viscous mounts that limit vibration and unnecessary sound. Add in special roof lining and sealing and you have a cab that's as quiet inside as any of today's top pickup trucks.

## Secure Contact Points

Multiple large steps get you into the cab as well as a leg up to the compartments. Extended hand and guard rails allow you to safely climb to the upper deck. Anti-skid plates reduce your slipping hazards in all types of weather conditions, and they can be removed for cleaning.

## Great Views

Ample glass gives you excellent visibility out front and to the side, and the available rearview camera gives you a clear field of view behind the machine through the cab monitor. The available split-configuration windshield features an upper window with handles that make it easy to slide and store above you and a lower window that can be removed and stored on the inside wall of the cab. The large skylight also serves as an emergency exit and provides you with enhanced overhead visibility.

## Smart Lighting

Halogen lights provide plenty of illumination, and the cab and boom lights can be programmed to stay on for up to 90 seconds after the engine has been turned off to help you safely exit the machine.

## Guard Options

The 320F can be equipped with several guarding options. Following are just a few offered by your local Cat dealer that will help protect you and your machine:

- Falling Object Guarding System (FOGS)
- Vandal guards
- Swivel guard

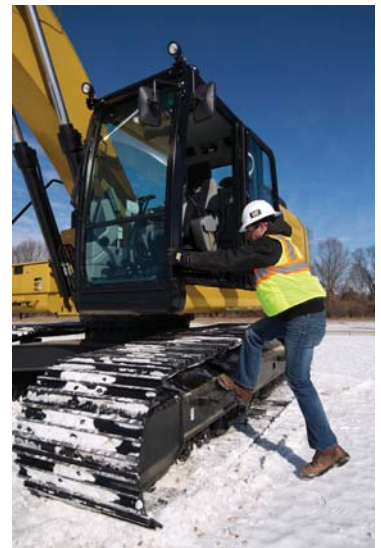
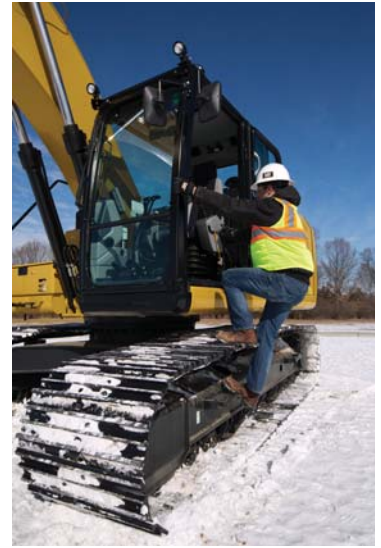



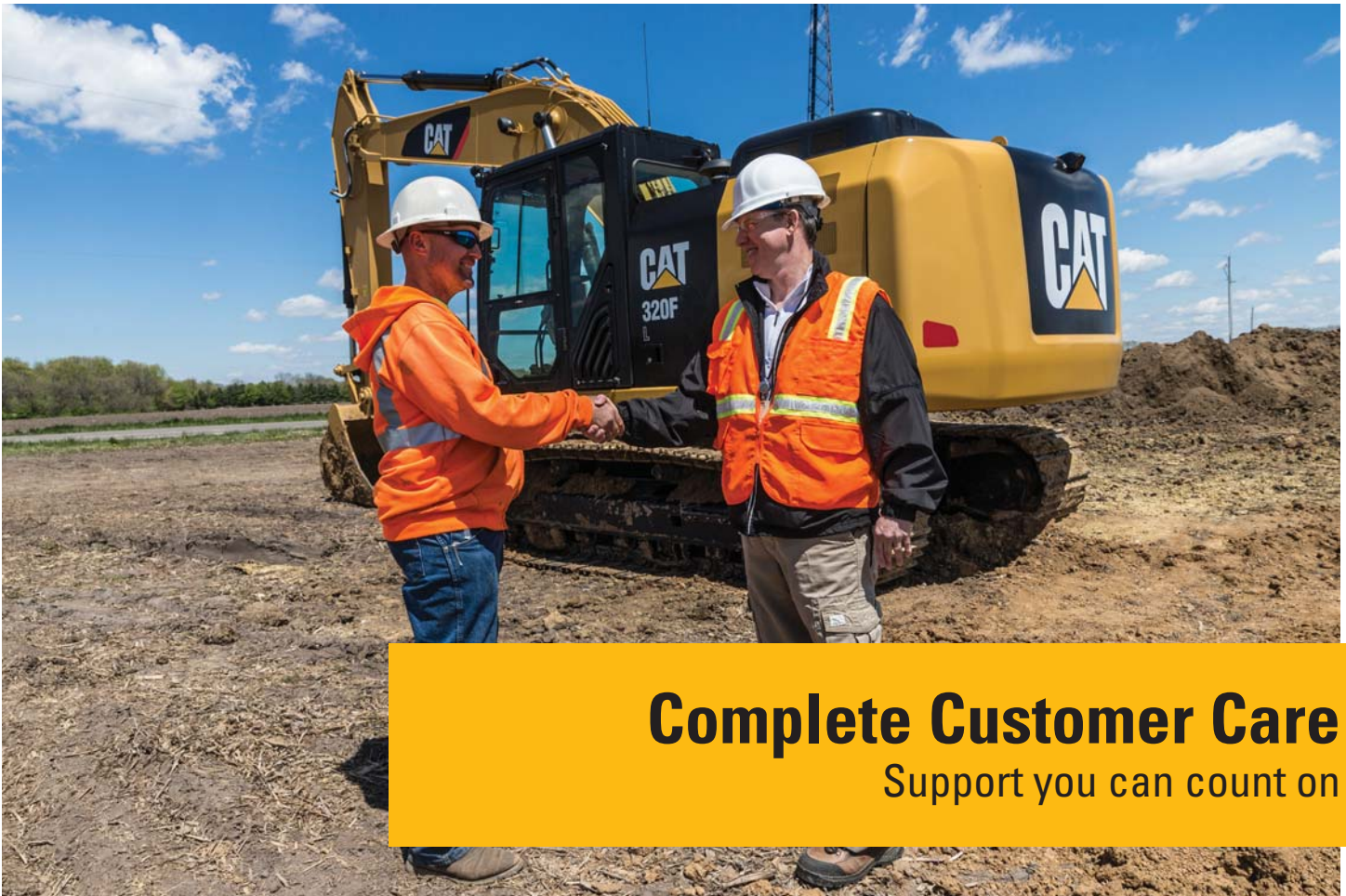

## Complete Customer Care

Support you can count on

### Expert Advice You Can Trust

What are the job requirements and machine attachments? What production is needed? Your Cat dealer can provide recommendations to help you make the right machine choices.

### Support Agreements To Fit Your Needs

Cat dealers offer a variety of customer support agreements and work with you to develop a plan to meet your specific needs. These plans can cover the entire machine, including attachments, to help protect your investment.

### Parts When And Where You Need Them

Cat dealers utilize a worldwide parts network to maximize your machines' uptime. Plus they can help you save money with Cat remanufactured components.

### Operating Techniques To Boost Your Profits

Improving operating techniques can boost your profits. Your Cat dealer has videos, literature, and other ideas to help you increase productivity. Caterpillar also offers simulators and certified operator training to help maximize the return on your investment.

### Financial Options Just For You

Consider financing options and day-to-day operating costs. Look at dealer services that can be included in the machine's cost to yield lower owning and operating costs over time.

### What's Best For You Today...And Tomorrow

Repair, rebuild, or replace? Your Cat dealer can help you evaluate the cost involved so you can make the best choice for your business.



## Sustainability

Generations ahead in every way

- The C4.4 ACERT engine is miserly on fuel and meets Tier 4 Final emission standards.
- The engine can run on either ultra-low-sulfur diesel (ULSD) fuel with 15 ppm of sulfur or less or biodiesel (up to B20) fuel blended with ULSD.
- A ground-level overfill indicator rises when the tank is full to help the operator avoid spilling.
- The machine is built to be rebuilt with major structures and components capable of being remanufactured to reduce waste and replacement costs.
- The 320F L is an efficient, productive machine that's designed to conserve our natural resources for generations ahead.

# 320F L Hydraulic Excavator Specifications

## Engine

Engine Model	Cat C4.4 ACERT	
Engine Power – ISO 14396	122 kW	164 hp
Net Power – SAE J1349	120 kW	161 hp
Bore	105 mm	4.13 in
Stroke	127 mm	5.00 in
Displacement	4.4 L	269 in <sup>3</sup>

- The 320F meets Tier 4 Final emission standards.
- No engine power derating required below 3000 m (9,800 ft) altitude.
- Net power advertised is the power available at the flywheel when the engine is equipped with fan, air cleaner, muffler and alternator.
- Rating at 1,800 rpm.

## Weights

Operating Weight	22 300 kg	49,200 lb
------------------	-----------	-----------

• Reach Boom, R2.9 m (9'6") stick, GD 1.19 m<sup>3</sup> (1.56 yd<sup>3</sup>) bucket and 790 mm (31") TG shoes.

## Track

Number of Shoes Each Side	49 pieces	
Number of Track Rollers Each Side	8 pieces	
Number of Carrier Rollers Each Side	2 pieces	

## Swing Mechanism

Swing Speed	11.2 rpm	
Swing Torque	61.8 kN·m	45,581 lbf·ft

## Drive

Maximum Travel Speed – High	5.6 km/h	3.5 mph
Maximum Drawbar Pull	205 kN	46,086 lbf

## Hydraulic System

Main System – Maximum Flow (Total)	428 L/min	113.1 gal/min
Maximum Pressure – Equipment		
Heavy Lift	38 000 kPa	5,511 psi
Normal	35 000 kPa	5,076 psi
Maximum Pressure – Travel		
Maximum Pressure – Swing	25 000 kPa	3,626 psi
Pilot System – Maximum Flow (Total)	24.3 L/min	6.4 gal/min
Pilot System – Maximum Pressure	3920 kPa	569 psi
Boom Cylinder – Bore	120 mm	5 in
Boom Cylinder – Stroke	1260 mm	50 in
Stick Cylinder – Bore	140 mm	6 in
Stick Cylinder – Stroke	1504 mm	59 in
Bucket Cylinder – Bore	120 mm	5 in
Bucket Cylinder – Stroke	1104 mm	43 in

## Service Refill Capacities

Fuel Tank Capacity	410 L	108.3 gal
DEF Tank Capacity	21 L	5.5 gal
Cooling System	30 L	7.9 gal
Engine Oil	25 L	6.6 gal
Swing Drive	8 L	2.1 gal
Final Drive	8 L	2.1 gal
Hydraulic System (including tank)	260 L	68.7 gal
Hydraulic Tank	115 L	30.4 gal

## Sound Performance

ISO 6395 (external)	97 dB(A)
ISO 6396 (inside cab)	68 dB(A)

- When properly installed and maintained, the cab offered by Caterpillar, when tested with doors and windows closed according to ANSI/SAE J1166 OCT98, meets OSHA and MSHA requirements for operator sound exposure limits in effect at time of manufacture.
- Hearing protection may be needed when operating with an open operator station and cab (when not properly maintained or doors/windows open) for extended periods or in a noisy environment.

# 320F L Hydraulic Excavator Specifications

## Dimensions

All dimensions are approximate.

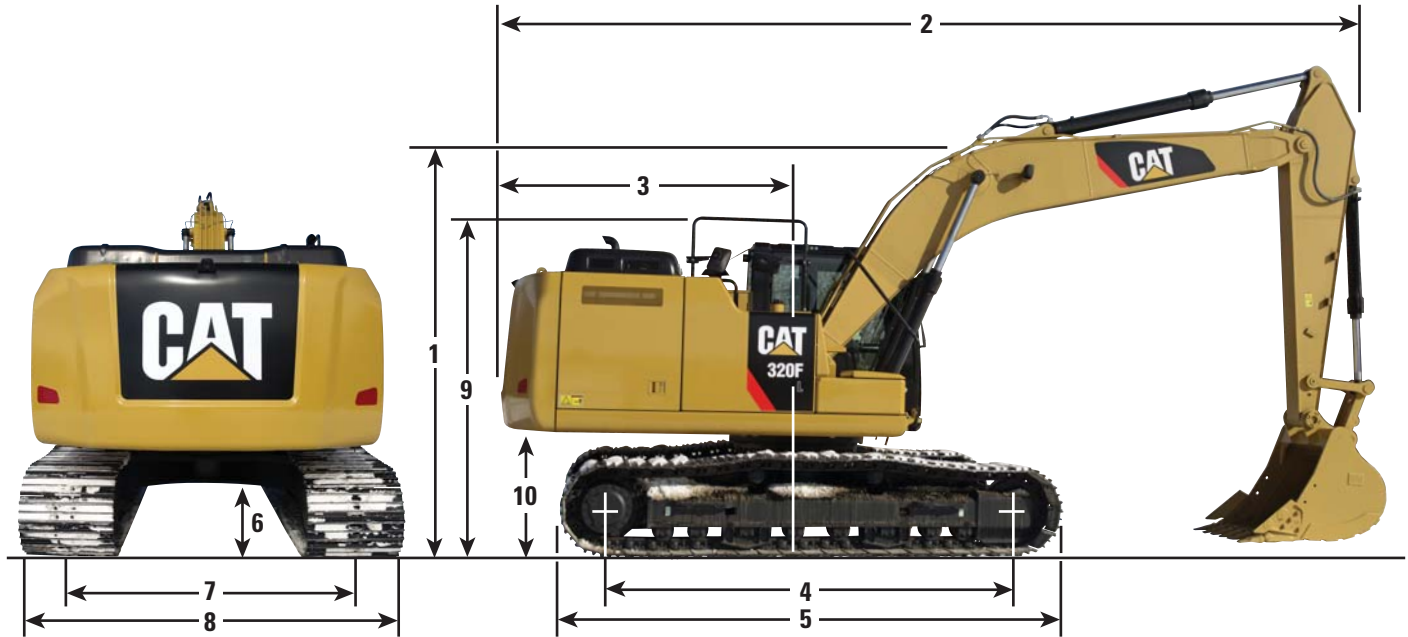

### Boom Options

Reach Boom  
5.7 m (18'8")

### Stick Options

R2.9 m\* (9'6")

1 Shipping Height	3130 mm	10'3"
2 Shipping Length	9540 mm	31'4"
3 Tail Swing Radius	2830 mm	9'3"
4 Length to Center of Rollers – Long Undercarriage	3650 mm	12'0"
5 Track Length – Long Undercarriage	4460 mm	14'8"
6 Ground Clearance	450 mm	1'6"
7 Track Gauge – Long Undercarriage (shipping)	2380 mm	7'10"
8 Transport Width – Long Undercarriage		
600 mm (24") Shoes	2980 mm	9'9"
700 mm (28") Shoes	3080 mm	10'1"
790 mm (31") Shoes	3170 mm	10'5"
9 Handrail Height	3010 mm	9'11"
10 Counterweight Clearance	1020 mm	3'4"

\*With 1.19 m<sup>3</sup> (1.56 yd<sup>3</sup>) Bucket and 790 mm (31 in) shoes

# 320F L Hydraulic Excavator Specifications

## Working Ranges

All dimensions are approximate.

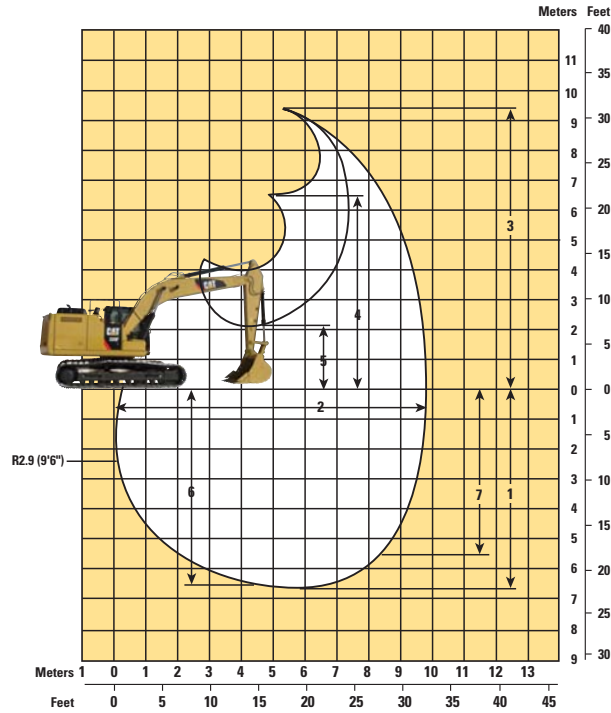

<b>Boom Options</b>	<b>Reach Boom – 5.7 m (18'8")</b>	
<b>Stick Options</b>	<b>R2.9 m (9'6")</b>	
Bucket	HD 1.19 m <sup>3</sup>	1.56 yd <sup>3</sup>
<b>1</b> Maximum Digging Depth	6720 mm	22'1"
<b>2</b> Maximum Reach at Ground Line	9860 mm	32'4"
<b>3</b> Maximum Cutting Height	9370 mm	30'9"
<b>4</b> Maximum Loading Height	6490 mm	21'4"
<b>5</b> Minimum Loading Height	2170 mm	7'1"
<b>6</b> Maximum Depth Cut for 2440 mm (8 ft) Level Bottom	6550 mm	21'6"
<b>7</b> Maximum Vertical Wall Digging Depth	5060 mm	16'7"
Bucket Digging Force (SAE)	134 kN	30,100 lbf
Bucket Digging Force (ISO)	150 kN	33,810 lbf
Stick Digging Force (SAE)	103 kN	23,220 lbf
Stick Digging Force (ISO)	106 kN	23,920 lbf

# 320F L Hydraulic Excavator Specifications

## Operating Weights and Ground Pressures

	600 mm (24") Shoes		700 mm (28") Shoes		790 mm (31") Shoes	
	kg (lb)	kPa (psi)	kg (lb)	kPa (psi)	kg (lb)	kPa (psi)
<b>Long Undercarriage</b>						
Reach Boom – 5.7 m (18'8")						
R2.9 m (9'6") Stick, 1.19 m <sup>3</sup> (1.56 yd <sup>3</sup> ) HD bucket	21 600 kg (47,600 lb)	45.0 kPa (6.5 psi)	22 000 kg (48,500 lb)	39.3 kPa (5.7 psi)	22 300 kg (49,200 lb)	35.2 kPa (5.1 psi)

## Major Component Weights

	kg	lb
Base Machine (with boom cylinder without counterweight, front linkage and track shoe)	7000	15,440
Long Undercarriage	4470	9,860
Counterweight	3700	8,160
Reach Boom (includes lines, pins and stick cylinder)		
5.7 m (18'8")	1740	3,840
Stick (includes lines, pins, bucket cylinder and bucket linkage)		
R2.9 m (9'6")	970	2,140
Track Shoes (long/per two track)		
600 mm (24") Triple Grouser	2690	5,930
700 mm (28") Triple Grouser	3070	6,770
790 mm (31") Triple Grouser	3360	7,410
Buckets		
HD 1.19 m <sup>3</sup> (1.56 yd <sup>3</sup> )	1060	2,340
GD 1.3 m <sup>3</sup> (1.7 yd <sup>3</sup> )	920	2,030

All weights are rounded up to nearest 10 kg and lb except for buckets. Kg and lb were rounded up separately so some of the kg and lb do not match.  
Base machine includes 75 kg (165 lb) operator weight, 90% fuel weight, and undercarriage with center guard.

# 320F L Hydraulic Excavator Specifications

## Work Tool Offering Guide\*

Boom Option	Reach Boom
Stick Option	R2.9 m HD (9'6")
Hydraulic Hammer	H115Es H120Es H130Es
Multi-Processor	MP318 CC Jaw MP318 D Jaw MP318 P Jaw^ MP318 S Jaw MP318 U Jaw^
Pulverizer	P215
Demolition and Sorting Grapple (D-Demolition shells, R-Recycling shells, WH-Waste Handling shells)	G315B-D/R G315B-WH
Scrap and Demolition Shear	S320B^ S325B#
Compactor (vibratory plate)	CVP110
Orange Peel Grapple	
Rippers	
Thumbs	
Pin Grabber Coupler	
Dedicated Quick Coupler	

These work tools are available for the 320F L.  
Consult your Cat dealer for proper match.

\* Offerings not available in all areas. Matches are dependent on excavator configurations. Consult your Cat dealer to determine what is offered in your area and for proper work tool match.

# Match; boom mount

^ Work over the front only with Cat-PG (match; Pin-on, Dedicated Quick Coupler and Cat-PG)

# 320F L Hydraulic Excavator Specifications

## Bucket Specifications and Compatibility

	Linkage	Width		Capacity		Weight		Fill	Reach Boom R2.9 m (9'6")
		mm	in	m <sup>3</sup>	yd <sup>3</sup>	kg	lb		
<b>Without Quick Coupler</b>									
General Duty (GDC)	B	600	24	0.55	0.72	618	1,363	100	●
	B	750	30	0.75	0.98	710	1,566	100	●
	B	900	36	0.95	1.24	786	1,733	100	●
	B	1050	42	1.16	1.52	847	1,867	100	⊙
	B	1200	48	1.38	1.80	925	2,038	100	⊖
Heavy Duty (HD)	B	1350	54	1.59	2.08	1002	2,209	100	⊖*
	B	600	24	0.46	0.61	649	1,430	100	●
	B	750	30	0.64	0.84	747	1,647	100	●
	B	900	36	0.81	1.06	825	1,818	100	●
	B	1050	42	1.00	1.31	879	1,937	100	●
Severe Duty (SD)	B	1200	48	1.19	1.56	970	2,138	100	⊖
	B	1350	54	1.38	1.81	1051	2,316	100	⊖*
	B	600	24	0.46	0.61	693	1,527	90	●
	B	750	30	0.64	0.84	801	1,765	90	●
	B	900	36	0.81	1.06	887	1,955	90	●
								90	●
								90	⊙
									⊙
Maximum load pin-on (payload + bucket)								kg	2940
								lb	6,480
<b>With Pin Grabber Coupler</b>									
General Duty (GDC)	B	600	24	0.55	0.72	618	1,363	100	●
	B	750	30	0.75	0.98	710	1,566	100	●
	B	900	36	0.95	1.24	786	1,733	100	⊙
	B	1050	42	1.16	1.52	847	1,867	100	⊖
	B	1200	48	1.38	1.80	925	2,038	100	⊖
Heavy Duty (HD)	B	1350	54	1.59	2.08	1002	2,209	100	⊖
	B	600	24	0.46	0.61	649	1,430	100	●
	B	750	30	0.64	0.84	747	1,647	100	●
	B	900	36	0.81	1.06	825	1,818	100	●
	B	1050	42	1.00	1.31	879	1,937	100	⊖
Severe Duty (SD)	B	1200	48	1.19	1.56	970	2,138	100	⊖
	B	1350	54	1.38	1.81	1051	2,316	100	⊖
	B	600	24	0.46	0.61	693	1,527	90	●
	B	750	30	0.64	0.84	801	1,765	90	●
	B	900	36	0.81	1.06	887	1,955	90	●
								90	●
								90	⊙
								90	⊖
Maximum load pin-on (payload + bucket)								kg	2530
								lb	5,577

The above loads are in compliance with hydraulic excavator standard EN474, they do not exceed 87% of hydraulic lifting capacity or 75% of tipping capacity with front linkage fully extended at ground line with bucket curled.

Capacity based on ISO 7451.

Bucket weight with General Duty tips.

\*For light dirt loading applications only. Consult your dealer to understand your application before using this bucket in combination with this stick.

### Maximum Material Density:

- 2100 kg/m<sup>3</sup> (3,500 lb/yd<sup>3</sup>)
- ⊙ 1800 kg/m<sup>3</sup> (3,000 lb/yd<sup>3</sup>)
- ⊖ 1500 kg/m<sup>3</sup> (2,500 lb/yd<sup>3</sup>)
- 1200 kg/m<sup>3</sup> (2,000 lb/yd<sup>3</sup>)
- ◇ 900 kg/m<sup>3</sup> (1,500 lb/yd<sup>3</sup>)

Caterpillar recommends using appropriate work tools to maximize the value customers receive from our products. Use of work tools, including buckets, which are outside of Caterpillar's recommendations or specifications for weight, dimensions, flows, pressures, etc. may result in less-than-optimal performance, including but not limited to reductions in production, stability, reliability, and component durability. Improper use of a work tool resulting in sweeping, prying, twisting and/or catching of heavy loads will reduce the life of the boom and stick.



# 320F L Hydraulic Excavator Specifications

## Reach Boom Lift Capacities – Counterweight: 3.7 mt (8,160 lb) – with Bucket Linkages, without Bucket

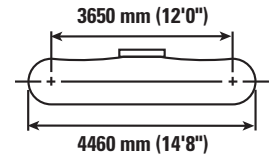
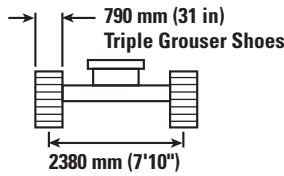
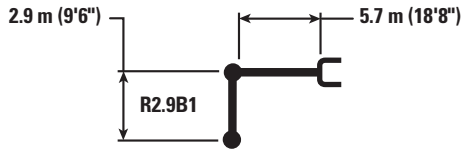

		1.5 m/5.0 ft		3.0 m/10.0 ft		4.5 m/15.0 ft		6.0 m/20.0 ft		7.5 m/25.0 ft		m ft		
7.5 m 25.0 ft	kg lb							*4950	*4950			*4300 *9,500	*4300 *9,500	6.15 20.00
6.0 m 20.0 ft	kg lb							*5400 *11,850	5400 11,550			*3950 *8,750	3900 8,700	7.29 24.20
4.5 m 15.0 ft	kg lb							*5950 *12,900	5200 11,250	*5600 12,200	3700 7,900	*3900 *8,550	3300 7,350	7.99 26.70
3.0 m 10.0 ft	kg lb					*8650 *18,650	7600 16,350	*6800 *14,800	5000 10,700	5600 11,950	3600 7,700	*4000 *8,750	3050 6,650	8.36 27.50
1.5 m 5.0 ft	kg lb					*10 500 *22,650	7050 15,250	7600 16,350	4750 10,200	5450 11,700	3450 7,450	*4200 *9,250	2900 6,400	8.45 28.30
0 m 0 ft	kg lb			*6600 *15,150	*6600 *15,150	*11 500 *24,900	6800 14,600	7400 15,900	4550 9,850	5350 11,500	3400 7,250	*4650 *10,250	2950 6,500	8.26 27.50
-1.5 m -5.0 ft	kg lb	*7050 *15,750	*7050 *15,750	*11 400 *25,850	*11 400 *25,850	11 600 24,850	6700 14,450	7350 15,750	4500 9,700	5350 11,450	3350 7,200	5050 11,200	3200 7,050	7.78 25.80
-3.0 m -10.0 ft	kg lb	*12 100 *27,100	*12 100 *27,100	*15 450 *33,400	13 100 28,100	*10 900 *23,550	6800 14,600	7350 15,850	4550 9,750			6000 13,300	3750 8,350	6.95 23.30
-4.5 m -15.0 ft	kg lb			*12 350 *26,400	*12 350 *26,400	*8850 *18,900	7000 15,100					*6700 *14,750	5200 11,700	5.60 18.30



ISO 10567



\*Indicates that the load is limited by hydraulic lifting capacity rather than tipping load. The above loads are in compliance with hydraulic excavator lift capacity standard ISO 10567:2007. They do not exceed 87% of hydraulic lifting capacity or 75% of tipping load. Weight of all lifting accessories must be deducted from the above lifting capacities. Lifting capacities are based on the machine standing on a firm, uniform supporting surface. The use of a work tool attachment point to handle/lift objects, could affect the machine lift performance.

Lift capacity stays with ±5% for all available track shoes.

Always refer to the appropriate Operation and Maintenance Manual for specific product information.

# 320F L Hydraulic Excavator Specifications

## Reach Boom Lift Capacities – Counterweight: 3.7 mt (8,160 lb) – with Bucket Linkages, without Bucket

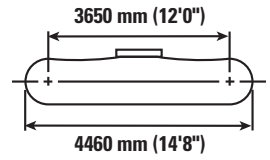
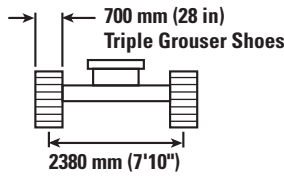
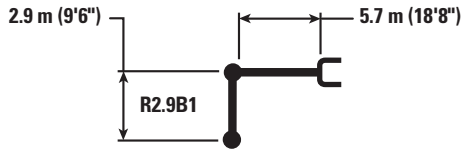

		1.5 m/5.0 ft		3.0 m/10.0 ft		4.5 m/15.0 ft		6.0 m/20.0 ft		7.5 m/25.0 ft		m ft		
7.5 m 25.0 ft	kg lb							*4950	*4950			*4300 *9,500	*4300 *9,500	6.15 20.00
6.0 m 20.0 ft	kg lb							*5400 *11,850	5300 11,400			*3950 *8,750	3850 8,600	7.29 24.20
4.5 m 15.0 ft	kg lb							*5950 *12,900	5150 11,100	*5600 12,050	3650 7,800	*3900 *8,550	3300 7,250	7.99 26.70
3.0 m 10.0 ft	kg lb					*8650 *18,650	7500 16,150	*6800 *14,800	4900 10,600	5500 11,800	3550 7,600	*4000 *8,750	3000 6,600	8.36 27.50
1.5 m 5.0 ft	kg lb					*10 500 *22,650	7000 15,050	7500 16,150	4700 10,100	5400 11,550	3400 7,350	*4200 *9,250	2900 6,350	8.45 28.30
0 m 0 ft	kg lb			*6600 *15,150	*6600 *15,150	*11 500 24,750	6700 14,450	7300 15,700	4500 9,700	5300 11,350	3350 7,150	4600 10,150	2950 6,450	8.26 27.50
-1.5 m -5.0 ft	kg lb	*7050 *15,750	*7050 *15,750	*11 400 *25,850	*11 400 *25,850	11 450 24,500	6650 14,250	7250 15,550	4450 9,550	5250 11,300	3300 7,150	5000 11,050	3150 6,950	7.78 25.80
-3.0 m -10.0 ft	kg lb	*12 100 *27,100	*12 100 *27,100	*15 450 *33,400	12 950 27,750	*10 900 *23,550	6700 14,400	7300 15,650	4500 9,650			5900 13,100	3700 8,250	6.95 23.30
-4.5 m -15.0 ft	kg lb			*12 350 *26,400	*12 350 *26,400	*8850 *18,900	6900 14,900					*6700 *14,750	5150 11,550	5.60 18.30



ISO 10567



\*Indicates that the load is limited by hydraulic lifting capacity rather than tipping load. The above loads are in compliance with hydraulic excavator lift capacity standard ISO 10567:2007. They do not exceed 87% of hydraulic lifting capacity or 75% of tipping load. Weight of all lifting accessories must be deducted from the above lifting capacities. Lifting capacities are based on the machine standing on a firm, uniform supporting surface. The use of a work tool attachment point to handle/lift objects, could affect the machine lift performance.









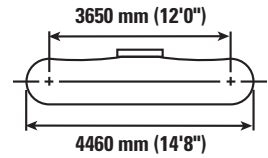
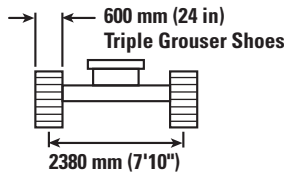
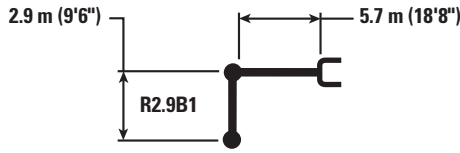



Lift capacity stays with ±5% for all available track shoes.

Always refer to the appropriate Operation and Maintenance Manual for specific product information.

# 320F L Hydraulic Excavator Specifications

## Reach Boom Lift Capacities – Counterweight: 3.7 mt (8,160 lb) – with Bucket Linkages, without Bucket



		1.5 m/5.0 ft		3.0 m/10.0 ft		4.5 m/15.0 ft		6.0 m/20.0 ft		7.5 m/25.0 ft				m ft
														
7.5 m 25.0 ft	kg lb							*4950	*4950			*4300	*4300	6.15 20.00
6.0 m 20.0 ft	kg lb							*5400 *11,850	5250 11,250			*3950 *8,750	3800 8,450	7.29 24.20
4.5 m 15.0 ft	kg lb							*5950 *12,900	5100 10,950	5550 11,850	3600 7,650	*3900 *8,550	3200 7,100	7.99 26.70
3.0 m 10.0 ft	kg lb					*8650 *18,650	7400 15,900	*6800 *14,800	4850 10,450	5400 11,650	3500 7,450	*4000 *8,750	2950 6,450	8.36 27.50
1.5 m 5.0 ft	kg lb					*10 500 *22,650	6900 14,800	7400 15,850	4600 9,900	5300 11,350	3350 7,250	*4200 *9,250	2850 6,200	8.45 28.30
0 m 0 ft	kg lb			*6600 *15,150	*6600 *15,150	11 350 24,300	6600 14,200	7200 15,450	4450 9,550	5200 11,150	3300 7,050	4550 9,950	2900 6,300	8.26 27.50
-1.5 m -5.0 ft	kg lb	*7050 *15,750	*7050 *15,750	*11 400 *25,850	*11 400 *25,850	11 250 24,100	6500 14,000	7100 15,300	4350 9,400	5150 11,100	3250 7,000	4900 10,850	3100 6,850	7.78 25.80
-3.0 m -10.0 ft	kg lb	*12 100 *27,100	*12 100 *27,100	*15 450 *33,400	12 750 27,300	*10 900 *23,550	6600 14,150	7150 15,400	4400 9,500			5800 12,900	3650 8,100	6.95 23.30
-4.5 m -15.0 ft	kg lb			*12 350 *26,400	*12 350 *26,400	*8850 *18,900	6800 14,650					*6700 *14,750	5050 11,350	5.60 18.30



ISO 10567



\*Indicates that the load is limited by hydraulic lifting capacity rather than tipping load. The above loads are in compliance with hydraulic excavator lift capacity standard ISO 10567:2007. They do not exceed 87% of hydraulic lifting capacity or 75% of tipping load. Weight of all lifting accessories must be deducted from the above lifting capacities. Lifting capacities are based on the machine standing on a firm, uniform supporting surface. The use of a work tool attachment point to handle/lift objects, could affect the machine lift performance.

Lift capacity stays with ±5% for all available track shoes.

Always refer to the appropriate Operation and Maintenance Manual for specific product information.

# 320F L Standard Equipment

## Standard Equipment

Standard equipment may vary. Consult your Cat dealer for details.

### ENGINE

- Diesel engine, C4.4 ACERT that meets Tier 4 Final emission standards
  - Two selectable power modes capability; STD and ECO
  - Aftertreatment system: CEM (DOC + DPF + SCR) and DEF system (DEF Tank and DEF Lines)
- Variable fan speed control with viscous clutch
- One-touch low idle
- Automatic (programmable) idling shut down function
- Three-stage fuel filtration system with water separator and indicator
- 3000 m (9,800 ft) altitude capability without derate
- 52° C (126° F) high-ambient cooling capability with derate from 48° C (118° F)
- 85 amp alternator
- Radial seal air filter with double filter element
- Electric fuel lifting pump
- Capability of using biodiesel up to B20
- Starting kit for –18° C (0° F)

### HYDRAULIC

- Electric boom regeneration circuit
- Stick regeneration circuit
- One-touch lifting mode
- Automatic two-speed travel
- Boom and stick drift reduction valve
- Reverse swing damping valve
- High-performance hydraulic return filter (capsule filter type)
- CRN compliant accumulator
- Fine swing control

### CAB

- Sound suppressed ROPS cab (ISO 12117-2 compliant) with viscous mount
- Openable skylight as emergency exit (dual exit hatch)
- Openable laminated front upper windshield with assist device
- Removable tempered lower windshield with in-cab storage bracket
- High back seat with air suspension, seat heater and head rest
- Fully adjustable seat, console and armrest
- Seat belt
- LCD monitor with distortion-free rearview camera picture
- Automatic bi-level air conditioner with pressurized function
- 12V × 2 power supply with sockets (maximum 10 amp)
- Washable floor mat
- Roll-down sun screen
- Interior utilities (interior lighting, coat hook, beverage holder, literature holder, document holding space, and cab rear storage compartment)
- 24V AM/FM radio (includes auxiliary input)
- Third pedal for straight travel

### UNDERCARRIAGE & STRUCTURES

- 3.7 mt (8,160 lb) counterweight
- Grease-lubricated track link
- Tie-down points on base frame (ISO 15818 compliant)

### ELECTRICAL

- Maintenance-free battery
- Centralized electrical disconnect switch
- Cat Product Link
- Programmable time delay working lights (halogen); storage box mounted (one), cab mounted (two), boom mounted (two)

### SERVICE & MAINTENANCE

- Engine oil, fuel, and hydraulic oil filters grouped for ease of maintenance
- Sampling ports for Scheduled Oil Sampling (S·O·S<sup>SM</sup>)
- Three side-by-side cooling package for easy maintenance

### SAFETY & SECURITY

- Rearview camera with three mirrors (ISO 5006 compliant) and one additional cab mirror
- Right-hand rail and hand hold (ISO 2867 compliant)
- Bolt-free service platform with anti-skid plate
- Neutral lever (lock out) for all controls
- Ground-level accessible secondary engine shutoff switch in cab
- Signaling/warning horn
- Safety hammer for cab evacuation
- Travel alarm

## Optional Equipment

Optional equipment may vary. Consult your Cat dealer for details.

### ENGINE

- Cold start, -32° C (-26° F) with jump start receptacle

### HYDRAULIC

- Tool control
- Medium-pressure circuit
- Quick coupler circuit for Cat Pin Grabber coupler

### CAB

- Joystick with modulation SW (one modulation switch and three on/off switch per IJ/S)
- Control pattern quick-changer, two way

### UNDERCARRIAGE & STRUCTURES

- HD 5.7 m (18'8") boom
- 2.9 m (9'6") stick
- Bucket linkage
- 790 mm (31") triple grouser shoes

### SAFETY & SECURITY

- Boom lowering control valve
- Stick lowering control valve
- FOGS (bolt-on)
- Guard, vandalism





For more complete information on Cat products, dealer services, and industry solutions, visit us on the web at [www.cat.com](http://www.cat.com)

AEHQ7644-01 (01-2016)  
Replaces AEHQ7644

© 2016 Caterpillar  
All rights reserved

Materials and specifications are subject to change without notice. Featured machines in photos may include additional equipment. See your Cat dealer for available options.

CAT, CATERPILLAR, SAFETY.CAT.COM, their respective logos, "Caterpillar Yellow" and the "Power Edge" trade dress, as well as corporate and product identity used herein, are trademarks of Caterpillar and may not be used without permission.

VisionLink is a trademark of Trimble Navigation Limited, registered in the United States and in other countries.

