

JLG® ELECTRIC POWERED

Aerial Work Platforms



JLG®

JLG® AERIAL WORK PLATFORMS REACHING OUT

Today, more people are demanding environmentally-friendly equipment. More municipalities are demanding "green" building for new construction and renovations. The JLG® line of electric powered aerial work platforms are the green machines in the lift industry.

JLG electric powered aerial work platforms feature longer run time, greater uptime and higher productivity. The energy-efficient electric drive boosts your productivity with industry-leading duty cycles.

These machines are specifically designed so you have fewer scheduled services, a quieter work area, less dependency on hydraulic oils and zero emissions.

From job start to completion, 12 ft to 60 ft, scissor lift, boom lift or mast lift, JLG has an electric lift to meet your needs and keep your job green.

RUNNING CLEANER AND LONGER

"With JLG machines, I can get the job done faster and with less impact on the environment."



**WHEN PRODUCTIVITY
NEEDS A BOOST**





TOUCAN 32E

jlg.com



READY TO WORK OVERTIME

Experience the benefits of reduced charging time and longer runtime with ES Series scissor lifts. You can stay on the job longer, getting more work done in one day. And the optional application-specific accessory packages enhance productivity.

With only two hoses and four fittings, you're working with a cleaner machine that decreases scheduled service requirements and reduces the chance for leaks.

Up to 1,000 lb capacity, proportional controls for ease of operation and optional accessory packages give you exactly what you need to get the job done.

"I'm always impressed with how much runtime we get before recharging."

DUAL CAPACITY

The 2632ES and 3246ES are rated for dual capacity. Restricted capacity on the 2632ES is 500 lb, and unrestricted is 800 lb. The 3246ES features 700 lb restricted and 1,000 lb unrestricted capacity.

NARROW OR WIDE PLATFORMS

The 2032ES and 2632ES feature 32-inch narrow platforms for access through standard doorways. The 2646ES and 3246ES provide a 46-inch platform for more worker tools or supplies.

ES SERIES



Longer Runtime

On a single charge, the electric drive delivers more than double the battery life of hydraulic drive machines.



One-Handed Operation

Fully proportional drive and lift control is smoother and more efficient.

VERSATILE ENOUGH FOR ANY WORKSITE

From commercial construction to hospitals, schools and facilities maintenance applications, the R Series can be used virtually anywhere there's work to be done. The ruggedness of thick rubber tires and all-steel component doors and platforms make them extremely reliable. R Series scissor lifts deliver the value you need without sacrificing performance and quality.

With platform capacities up to 770 lb, operators can reduce the number of trips to the ground for additional tools and materials. An optional MDI display and improved battery charger enhance uptime by assisting with trouble-shooting.

LOW COST OF OWNERSHIP

With a simplified pothole protection system that minimizes the number of moving parts and the associated repair costs, the R Series is a valuable solution for everyday job site needs.

IMPROVED SERVICEABILITY

With no stacked components, the R Series makes it easy for service personnel tackle the task at hand without having to remove other components.



R SERIES



Active Pothole Protection

Active pothole protection provides increased ground clearance.



Greater Serviceability

Improved battery charger and all-steel swing-out component tray and for greater serviceability.



OUTSTANDING PERFORMANCE, ON SLAB AND OFF

Handle a wide variety of terrain indoors and out, without noise and fumes thanks to the quiet operation and zero emissions of the LE Series. With the standard oscillating axle, 35% gradeability, rugged all-terrain tires and available all-wheel drive, you'll be able to go off the slab and into the mud with the LE Series scissor lifts.

There are four models available with working heights up to 46 ft and a maximum platform capacity of 1,000 lb. All models will fit through standard double doorways to get you to and from the work site.

The efficient direct electric drive system gives you the muscle you'll need for demanding jobs; and, you'll get double the duty cycles of other electric scissors with the deep cycle batteries. Plus, the M models have the Multi-Power feature, which has an on-board diesel-powered generator with improved fuel efficiency for lower costs.

LE SERIES



Off-Slab Mobility

Full-time automatic traction control and an oscillating axle boost off-slab productivity.



Platform Extension

A standard feature, the platform extension has a 250 lb capacity.

COMPACT. POWERFUL. PRODUCTIVE.

The ultra-compact 1230ES mast lift is compact enough to fit in a freight elevator and lightweight enough to be used on weight-sensitive floors. Its 5-inch turning radius navigates tight workspaces while heavy-duty steel wheels with non-marking rubber provide a more cushioned ride.

Charged and ready to go, the super-efficient electric drive increases your uptime and gives your productivity a lift. With 500 lb capacity, the 1230ES has the muscle to carry you and your gear, even at full height.

No chains, cables or rollers to grease or adjust in the mast means you've got lower maintenance requirements and operating costs. Plus, the 1230ES helps to keep your work environment clean; with only four hoses, you greatly reduce the chance for hydraulics leaks.

SALOON GATE

Saloon-style swing gate for ease of entry and exit.



98% CLEANER

Fewer hoses and couplings mean fewer potential leak points.



1230ES SERIES



Tool Tray

The workstation includes tool and fastener tray, 110V AC outlet and one-hand controller operation.



Serviceability

All-steel swing-out battery doors have heavy-duty hinges. Rugged design and strong 12 ft mast provide durability.



PUTS HARD TO REACH WITHIN REACH

With the JLG Toucan® vertical mast lift, you can meet your overhead challenges head-on. Work up, over and around assembly lines, shelving, ductwork or partitions more easily and without interferences. Positioning is easier with a 360° rotating mast, up to 32 ft of lift height and over 15 ft of jib reach. With its 500 lb capacity and a long-running, environmentally-friendly electric powered drive, the Toucan will help you boost productivity hour by hour, year after year.

BUILT TO TAKE ON YOUR FACILITY CHALLENGES

Plant maintenance, retooling and changeovers, warehousing, inspection and remodeling, general contracting — you can count on the Toucan Series to help keep production moving.

AS VERSATILE AS YOUR NEEDS

With thick rubber non-marking tires, clean and efficient electric power and 25% gradeability, you're equipped better than ever to meet your access challenges.

Smooth proportional controls, a narrow chassis and greater horizontal outreach are just some of the features that come standard and help you get the job done with greater speed and efficiency.

TOUCAN® SERIES



Work Cleaner

Thick rubber non-marking tires leave facility floors intact.



Greater Access

Compact dimensions for getting into hard-to-reach areas.

TURN THE CORNER ON PRODUCTIVITY

The E Series boom lifts are environmentally friendly with industry-leading performance. You can select from three platform heights and chassis widths—all with a 500 lb platform capacity—to best suit your work environment. The exclusive JibPLUS® articulating boom option has 180° range of side-to-side movement, providing you with even greater access to hard-to-reach places.

ROUND THE CLOCK PERFORMANCE

The E Series will keep you on the job longer than the competition with industry-leading duty cycles. The Multi-Power option gives you round-the-clock operation and faster battery charging with the QuikCharge GenSet Automatic Charging System.

MANEUVERABILITY. INSIDE AND OUT.

With automatic traction control, both drive wheels work independently for improved traction on uneven surfaces.



ELECTRIC SERIES



JibPLUS® Boom Option

Gain greater reach with 180-degree range of side-to-side movement.



Narrow Width

Accomplish more with greater maneuverability in tight spaces.



DIESEL-LIKE PERFORMANCE. HYBRID VERSATILITY.

The H340AJ and H800AJ models are 4WD boom lifts that combine diesel-like performance with the benefits of hybrid efficiency, so you can tackle jobs inside and out. By reducing fuel consumption and lowering maintenance costs, these hybrids offer a lower total cost of ownership.

SAME POWER AND PERFORMANCE

New hybrid models have similar components to their diesel counterparts, so you get uncompromising performance with the benefits of hybrid technology.



INDOOR AND OUTDOOR USE

Less noise and lower emissions give access to job sites where traditional diesel machines are not allowed to operate. For enclosed facilities, that means a less disruptive, more productive working environment.



ENHANCED FUEL EFFICIENCY

Using up to 40% less fuel*, these versatile boom lifts combine electrical and mechanical power to tackle rough terrain and navigate inclines.

H340AJ & H800AJ



Reduced Maintenance

With maintenance-free AGM batteries and a smaller Tier 4 Final engine, maintenance and service requirements are reduced.



Low Emissions

Experience reduced fuel use*, emissions, noise and maintenance.

* Compared to a diesel-powered JLG 340AJ under similar test conditions. Actual results may vary.

CLEAN AND GREEN, 60-FT MACHINE

The E600 series gives you the most height in an electric powered boom lift and over 43 ft of horizontal outreach. With four configurations, you can choose from electric or multi-power, standard jib or horizontally pivoting jib with JibPLUS.®

A 15,000 lb (6,804 kg) low gross vehicle weight and non-marking all-terrain tires let you work on slab or off, without hesitation. With the Automatic Traction Control, optional all-wheel drive and standard oscillating axle, you won't need to be shy about travelling over rough terrain.



Whether your jobs include industrial applications, maintenance, construction, or anything in between, the E600 Series delivers with zero emissions and reduced noise levels.



E600 SERIES



Optional All-Wheel Drive

Power through difficult terrain on the job site.



Environmentally-Friendly

Electric power system makes it possible to deliver zero emissions.

REACH WHAT OTHERS CAN'T

Now you can go more places around the job site thanks to the low weight and rubber tracks on JLG® Compact Crawler Boom lifts. Available in four models with working heights ranging from 50 ft to 84 ft, the compact crawler booms feature a tracked wheel carriage that climbs steps and a narrow chassis for access through gates, yards, standard doorways and public buildings. Its light weight, compact design allows for low floor loading and ease of transport.



You also get the advantage of a first-to-market environmentally-friendly power system on these machines — they are outfitted with an optional breakthrough Lithium-Ion electrical system that produces zero emissions and longer runtime, so the compact crawler boom runs clean while staying green.

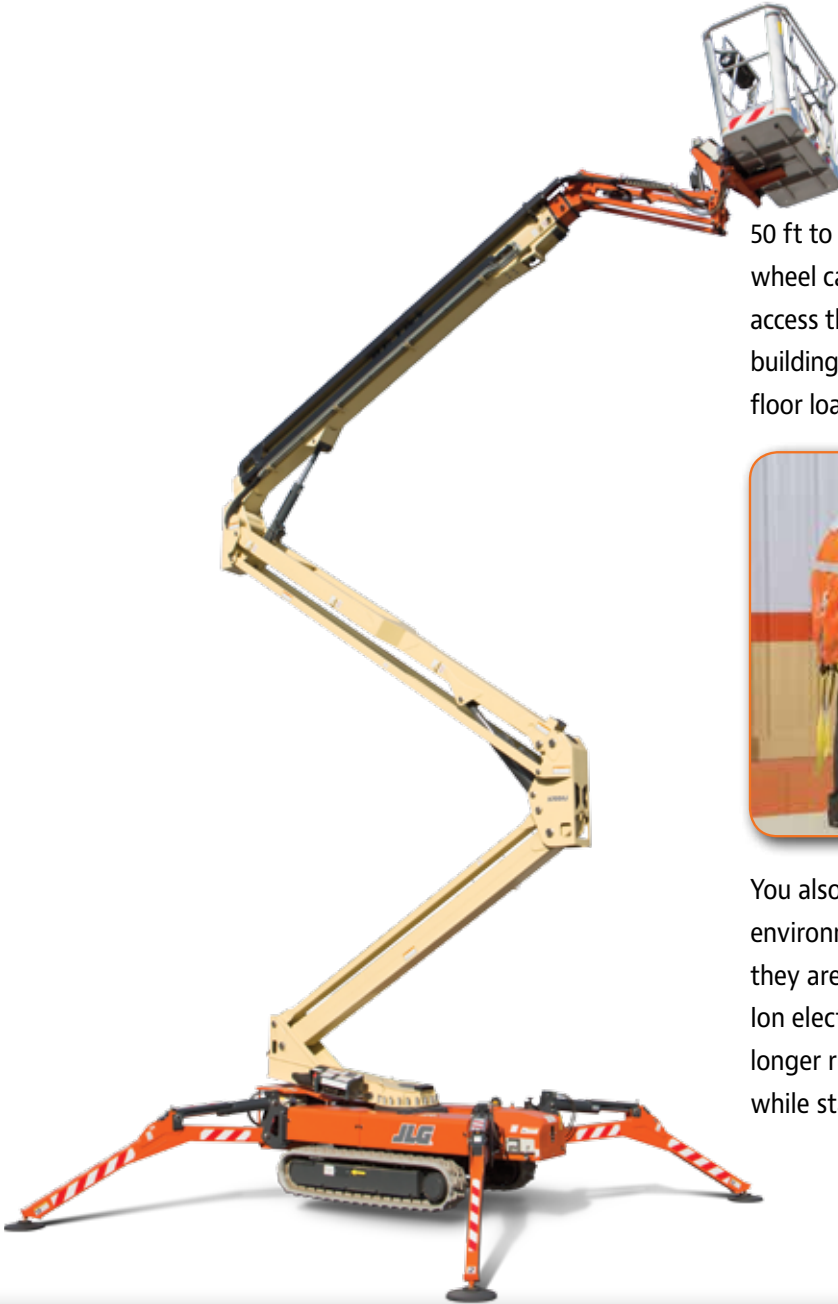

COMPACT CRAWLER SERIES



Enhanced Control Panel

Operator-friendly controls have one-touch outrigger leveling and interactive display in platform.



Ease of Transport

Fits on a trailer or tilt-back truck (low weight, good gradeability, compact).

TOW-PRO® GOES WHEREVER YOU GO

The Tow-Pro® Series lets you tackle the same jobs as the other JLG® electric boom lifts, but with an easier option for transportation. You also have the choice of a 24V DC electric or gas-powered engine. And with the standard combination hitch, industry-leading 65 mph towing speed and hydraulic auto-leveling outriggers, you can have the Tow-Pro to the job site and working in no time.

Standard air and water lines to the platform let you tackle a variety of jobs, including residential maintenance, construction, pressure washing, tree trimming, exterior painting and maintenance tasks, with greater ease. Two models offer platform heights of 35 ft or 50 ft, and both have a 500 lb capacity for you and your tools.



EASY ACCESS

The articulating jib on the T500J gets you into those hard-to-reach places.



OPTIONAL GENERATOR

An accessory mounting tray accommodates a generator, air compressor or pressure washer.



TOW-PRO SERIES



Innovative Controls

Detachable platform controls provide faster and more efficient boom positioning with one-hand operation of all boom functions.



Ease of Transport

A standard combination hitch and adjustable height coupler make it easy to attach the Tow-Pro to most vehicles.



PUTTING YOUR WORK ABOVE EVERYTHING

When it comes to JLG® Support, it's all about you. Your productivity. Your profitability. Your uptime. From the purchase of your first piece of equipment straight through to the training, parts and maintenance that follows.



■ **Customer Service Call Center**

You can be assured we'll be giving an all-out effort to support you. Just think of us as your personal on-call, full-service support team. We make it happen. Period.

■ **Financial Solutions**

Maximizing your profits. Preserving your cash flow. Let our financing specialists help choose the program designed specifically for your needs.

■ **Aftermarket Parts**

Keep your equipment running at peak performance with genuine replacement parts, accessories, attachments, rebuilt and competitive parts all from one source — JLG.

■ **Training**

Knowing your equipment inside and out results in higher productivity on the job. Our instructor-led courses give you the hands-on time you need to successfully operate equipment.

■ **Service Centers**

Your needs. Your uptime. JLG is on the job to fulfill your every need, from repair, reconditioning, same-day parts and much more. We're here to support you.

■ **Pre-Owned Equipment**

As a high-value alternative to purchasing new equipment, you can search our used equipment inventory of pre-owned JLG and competitor products.

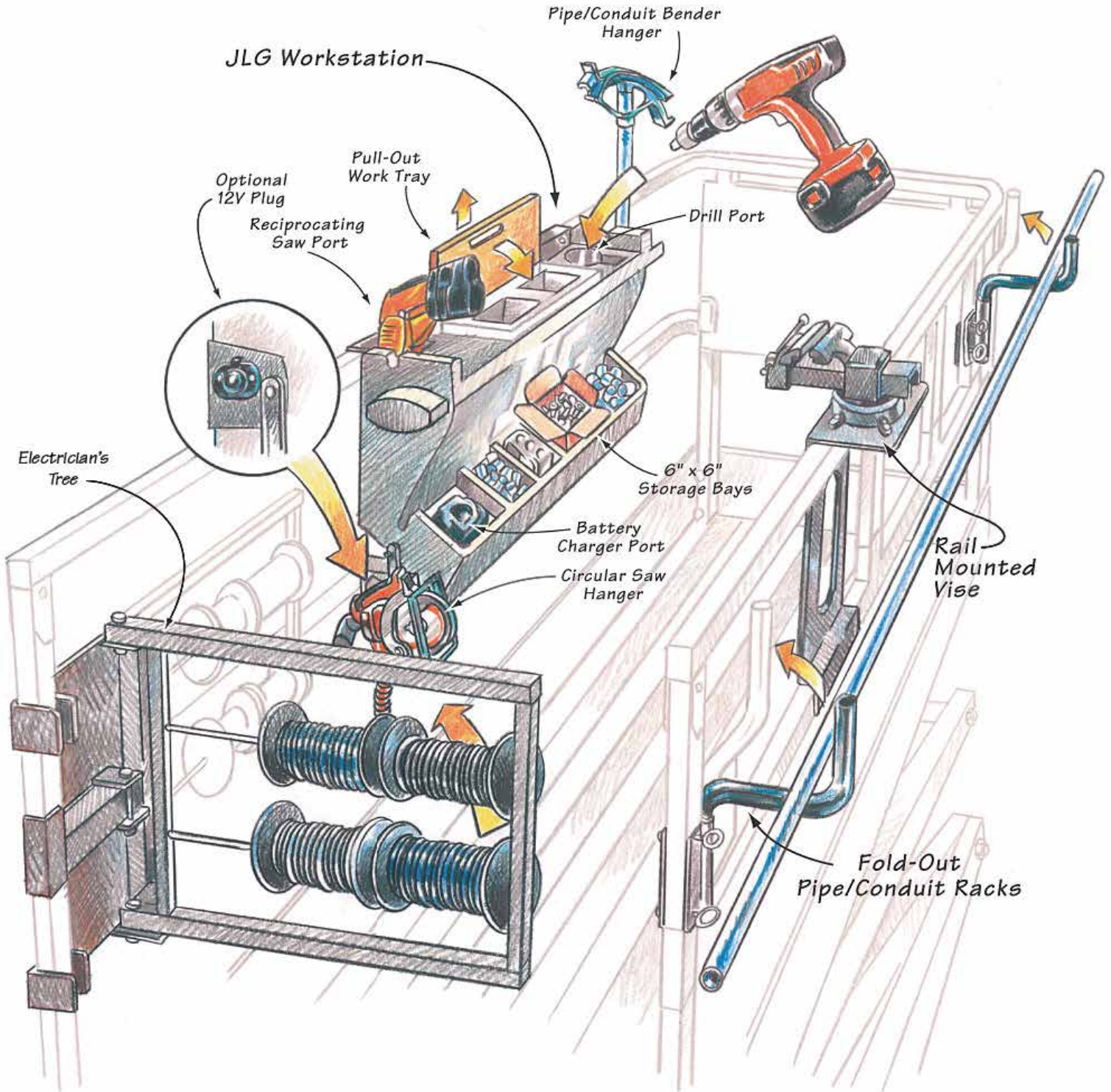

Optional Workstation in the Sky® accessory packages are designed for the specific needs of electricians, plumbers, contractors and plant maintenance professionals.

ACCESSORIES THAT EXTEND YOUR SCISSOR LIFT'S VERSATILITY

Workstation in the Sky® accessory packages are designed to keep your tools and components within arm's reach. Choose from packages that feature a removable workstation that optimizes platform space with compartments for tools such as a reciprocating saw, drill, circular saw, battery charger and 6 in. x 6 in. component boxes. Plus, a pull-out tray is included to provide a flat working surface near the top of the rails.

PLUMBER'S PACKAGE

Manufacturer-approved pipe racks provide positive retention of materials for plumbing contractors, while storage outside the platform helps prevent rail damage and optimizes space.

ELECTRICIAN'S PACKAGE

For electrical contractor applications that require battery-powered tools, the JLG® workstation keeps your tools within reach and off the floor of the platform. A stowable workbench and molded pockets provide ample storage while leaving the workspace open to get the job done. Electrician's Tree carries six 500 ft wire spools to speed up wire pulling and reduce friction associated with ground-based wire trees.

PLANT MAINTENANCE PACKAGE

The Plant Maintenance Package combines popular elements of the Electrician and Plumber packages to help plant maintenance professionals perform tasks, ranging from general repair to electrical and mechanical installation. In addition, a small welder powered by the machine batteries is included for light repairs.

ES SERIES ACCESSORIES					
	1930ES	2032ES	2632ES	2646ES	3246ES
Electrician's Package	N/A	N/A	N/A	•	•
Plumber's Package	N/A	N/A	N/A	•	•
Plant Package	N/A	N/A	N/A	•	•
Workstation w/o 12V Plug	•	•	•	•	•
Workstation w/12V Plug	•	•	•	•	•
Panel Carrier	N/A	•	•	•	•
Quik Welder® by Miller®	•	•	•	•	•
Pipe Racks	N/A	•	•	•	•
Vise	N/A	N/A	N/A	•	•
Electrician's Tree	•	•	•	•	•



JLG® Electric Powered Aerial Work Platforms SPECIFICATIONS

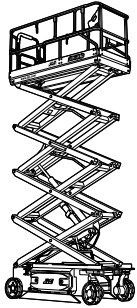

	1930ES	2032ES	2632ES	2646ES	3246ES
ES Series Electric Scissor Lifts					
Platform Height	18 ft 9 in. (5.72 m)	20 ft (6.10 m)	25 ft 6 in. (7.77 m)	26 ft (7.92 m)	31 ft 9 in. (9.68 m)
Platform Capacity	500 lb (227 kg)	800 lb (363 kg)	500/800 lb (227/363 kg)	1,000 lb (454 kg)	700/1,000 lb (318/454 kg)
Platform Size	30x73.5 in. (0.76x1.87m)	30x90.5 in. (0.76x2.3 m)	30x90.5 in. (0.76x2.3 m)	44x98.5 in. (1.12x2.5 m)	44x98.5 in. (1.12x2.5 m)
Overall Width	30 in. (76 cm)	32 in. (81 cm)	32 in. (81 cm)	46 in. (1.17 m)	46 in. (1.17 m)
Weight	2,710 lb (1,230 kg)	3,610 lb (1,638 kg)	4,635 lb (2,103 kg)	4,975 lb (2,257 kg)	4,975 lb (2,257 kg)
Power Source	4 x 6V 220 amp-hr	4 x 6V 220 amp-hr	4 x 6V 220 amp-hr	4 x 6V 220 amp-hr	4 x 6V 220 amp-hr

Main Features

- Best on-the-job performance—Double duty cycles for longer operating times, tight turning radius for maneuvering and positioning and a rugged design.
- Narrow aisle models—Efficiently access hard-to-reach areas for more productive maintenance projects.
- Revolutionary new Workstation in the Sky® options and accessories.

Available Options

1000 Watt—AC Inverter/Charger	•	•	•	•	•
Flashing Amber Beacon	•	•	•	•	•
Spring-Loaded Gate	•	•	•	•	•
245 Amp-Hour Batteries	•	•	•	•	•
AGM Batteries	•	•	•	•	•
Lifting Lugs	•	•	•	•	•
UL® EE Rating	•	•	•	•	•
Platform Padding	•	•	•	•	•
Platform Padding with Proximity Switches	•	•	•	•	•
1/2 in. Air Line to Platform	•	•	•	•	•
Nite Bright	•	•	•	•	•

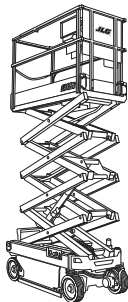

	1532R	1932R	4045R
R Series Electric Scissor Lift			
Platform Height Indoor/Outdoor	15 ft (4.57 m)	19 ft (5.8 m)	39 ft 3 in./29 ft (11.97 m/8.8 m)
Platform Capacity Indoor/Outdoor	600 lb (272 kg)	550 lb (250 kg)	770 lb/550 lb (350 kg/250 kg)
Platform Size	62.7 x 25.4 in. (1.59 x .64 m)	62.7 x 25.4 in. (1.59 x .64 m)	96 x 44 in. (2.43 x 1.13 m)
Overall Width	32 in. (.81 cm)	32 in. (.81 m)	45 in. (114.3 cm)
Weight*	2,500 lb (1,134 kg)	2,630 lb (1,193 kg)	7,000 lb (3,175 kg)
Power Source	4 x 6V 220 amp-hr	4 x 6V 220 amp-hr	4 x 12V 220 amp-hr

Available Options

Flashing Amber Beacon	•	•	•
AGM Batteries	•	•	•
Spring-Loaded Gate	•	•	•

Main Features

- Up to 770 lb (350 kg) capacity for more tools and materials to get the job done
- Easy-to-use controls and 25 percent gradeability allow operators to work confidently on a variety of job sites
- Simple and reliable pothole protection system reduces calls and improves uptime

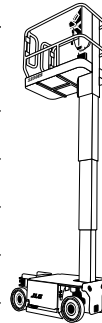

	1230ES
1230ES Electric Mast Lifts	
Platform Height	12 ft (3.66 m)
Platform Capacity	500 lb (227 kg)
Platform Size	39.7 x 27 in. (1.00 m x 0.68 m)
Overall Width	30 in. (76 cm)
Weight	1,740 lb (790 kg)
Power Source	4 x 6V 220 amp-hr

Available Options

1000 Watt—AC Inverter/Charger	•
Flashing Amber Beacon	•

Main Features

- Maintenance-free elevating mast design—No chains, cables or rollers to grease or adjust.
- Only four hydraulic hoses—Less to maintain, minimizes leak potential.
- Compact dimensions and low GVW—Fits on most elevators.

JLG® Electric Powered Aerial Work Platforms

SPECIFICATIONS

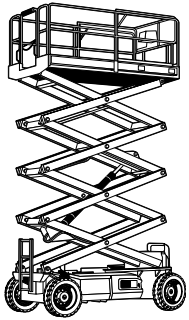

Main Features

- Double the duty cycles of competitive electric scissor lifts.
- Superior off-slab performance — Full-time automatic traction control system, standard oscillating axle and all-terrain tires.
- Powerful options — QuikCharge GenSet and all-wheel drive.
- Fold-down handrails.



Main Features

- 35 ft (10.4 m) and 50 ft (15.2 m) models.
- Hydraulic auto-leveling outriggers for faster and easier set-up.
- 24V DC electric or gasoline powered engine.
- Platform controls with one-hand operation of boom functions.
- Accessory Mounting Tray accommodates customer-provided generator, air compressor or pressure washer.
- Standard air and water lines to the platform.
- Optional Drive and Set from the platform.

	3369LE	M3369LE	4069LE	M4069LE
LE Series Large Electric Scissor Lifts				
Platform Height	33 ft (10.06 m)	33 ft (10.06 m)	40 ft (12.19 m)	40 ft (12.19 m)
Platform Capacity	1,000 lb (454 kg)	1,000 lb (454 kg)	800 lb (363 kg)	800 lb (363 kg)
Platform Size	65 x 115 in. (1.65 x 2.92 m)	65 x 115 in. (1.65 x 2.92 m)	65 x 115 in. (1.65 x 2.92 m)	65 x 115 in. (1.65 x 2.92 m)
Overall Width	5 ft 9 in. (1.75 m)	5 ft 9 in. (1.75 m)	5 ft 9 in. (1.75 m)	5 ft 9 in. (1.75 m)
Weight	9,760 lb (4,247 kg)	10,060 lb (4,563 kg)	10,560 lb (4,790 kg)	10,860 lb (4,926 kg)
Power Source	8 x 6V 370 amp-hr	8 x 6V 370 amp-hr	8 x 6V 370 amp-hr	8 x 6V 370 amp-hr
Generator Set—M models		45 amp Diesel Kubota		45 amp Diesel Kubota

Available Options

110V-AC Power Pack Inverter	•		•	
Flashing Amber Beacon	•	•	•	•
Hydraulic Leveling Jacks	•	•	•	•
Platform Worklights	•	•	•	•
Self-Closing Entry Gate	•	•	•	•
Foam-Filled Sand/Turf Tires	•	•	•	•
1/2 in. Air Line to Platform	•	•	•	•
Top Rail Padding	•	•	•	•
Rail and Deck Padding	•	•	•	•
Bio-Degradable Hydraulic Oil	•	•	•	•

	T350	T500J
Towable Boom Lifts		
Platform Height	34 ft 5 in. (10.5 m)	50 ft 9.5 in. (15.3 m)
Platform Capacity	500 lb (227 kg)	500 lb (227 kg)
Horizontal Outreach	20 ft 2 in. (6.14 m)	29 ft 5 in. (9.0 m)
Overall Width	4 ft 11.25 in. (1.5 m)	5 ft 7 in. (1.7 m)
Weight	3,400 lb (1,542 kg)	4,800 lb (2,177 kg)
Power Source—Electric	24V DC, 4 x 6V 220 amp-hr	24V DC, 4 x 6V 220 amp-hr
Gasoline Engine—Optional	Honda GX 270	Honda GX 270

Available Options

Platform Rotator	•	•
Material Hook—500 lb capacity	•	•
Platform Mounted Glass/Panel Tray	•	•
Non-Marking Outrigger Pads	•	•
Spare Tire—Full Size	•	•
Flashing Amber Beacon	•	•
Lifting Lugs	•	•
2,500 Watt Generator	•	•

JLG® Electric Powered Aerial Work Platforms SPECIFICATIONS



	E300AJ	E300AJP
E300 Series Electric Boom Lifts		
Platform Height	30 ft 2 in. (9.19 m)	29 ft 5 in. (8.96 m)
Platform Capacity	500 lb (227 kg)	500 lb (227 kg)
Horizontal Outreach	20 ft 3 in. (6.17 m)	20 ft 1 in. (6.14 m)
Up and Over Height	13 ft 2 in. (4.01 m)	13 ft 2 in. (4.01 m)
Overall Width	48 in. (1.22 m)	48 in. (1.22 m)
Weight	15,060 lb (6,831 kg)	15,400 lb (6,985 kg)
Power Source	48V DC 8 x 6V 305 amp-hr	48V DC 8 x 6V 305 amp-hr

Available Options

Platform Worklights	•	•
Mesh to Top Rail Bolt-On Aluminum	•	•
1/2 in. Air Line to Platform	•	•
1000 Watt Inverter	•	•
UL® EE Rating	•	•
375 amp-hr Batteries	•	•

Main Features

- 4 ft (1.22 m) articulating jib with optional JibPLUS®.
- ATC (Automatic Traction Control) improves performance on uneven surfaces.
- Ultra compact width of only 48 in. (1.22 m).
- Fast cycle times.

	H340AJ	H800AJ
H340AJ & H800AJ Articulating Boom Lifts		
Platform Height	33 ft 9 in. (10.28 m)	80 ft (24.38 m)
Platform Capacity	500 lb (227 kg)	500 lb (227 kg)
Horizontal Outreach	19 ft 11 in. (6.06 m)	51 ft 10 in. (15.8 m)
Up and Over Height	17 ft (5.17 m)	32 ft 1 in. (9.78 m)
Overall Width	6 ft 4 in. (1.93 m)	8 ft (2.44 m)
Weight	9,860 lb (4,472 kg)	35,400 lb (16,057 kg)
Power Source—Electric	8 x 12V 100 amp-hr	8 x 12V 100 amp-hr
Diesel Engine	Kubota Z482 11.1 hp (8.3 kW)	Kubota Tier 4 Final 30 hp (22.3 kW)

Available Options

30 x 48 in. (0.76 x 1.22 m) Platform	•	
Mesh to Top Rail (Bolt-on Aluminum)	•	•
1/2 in. Air Line to Platform	•	•
9 x 20 Foam-Filled Lug Tires	•	
9 x 20 Non-Marking Pneumatic Tires	•	
9 x 20 Non-Marking Foam-Filled Tires	•	
7 x 18 Solid Cushion Lug Tread Tires	•	
7 x 18 Non-marking Solid Cushion Lug Tread Tires	•	
AC Generator	•	•
Chassis Illumination Lights	•	•
Platform Worklights	•	•
Hostile Environment Kit	•	•
Flashing Amber Beacon	•	•
Special Hydraulic Oils	•	•
Self Closing Gate	•	•

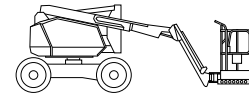

Main Features

- Tier 4 Final, diesel-powered generator produces fewer emissions.
- 8 x 12v 100 amp-hour AGM batteries deliver longer runtime.
- Four direct electric drive motors provide optimal off-slab productivity with enough power for 45% gradeability.
- Four-wheel drive for exceptional terrainability.

JLG® Electric Powered Aerial Work Platforms

SPECIFICATIONS

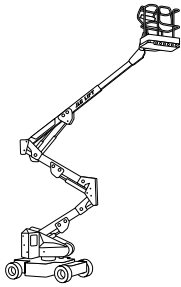

Main Features

- JibPLUS® models provide access in and around confined work areas.
- 4 ft 11 in. narrow chassis model for maneuvering in narrow aisles and confined areas.
- ATC (Automatic Traction Control) improves performance on uneven surfaces.
- QuikCharge GenSet option provides automatic charging for continuous machine operation.

	E400A Narrow	E400AJP M400AJP	E400AJP Narrow M400AJP Narrow
E400/M400 Series Electric Boom Lifts			
Platform Height	40 ft (12.19 m)	40 ft (12.19 m)	40 ft (12.19 m)
Platform Capacity	500 lb (227 kg)	500 lb (227 kg)	500 lb (227 kg)
Horizontal Outreach	21 ft 2 in. (6.45 m)	22 ft 5 in. (6.83 m)	22 ft 5 in. (6.83 m)
Up and Over Height	21 ft 6 in. (6.55 m)	21 ft 6 in. (6.55 m)	21 ft 6 in. (6.55 m)
Overall Width	4 ft 11 in. (1.50 m)	5 ft 9 in. (1.75 m)	4 ft 11 in. (1.50 m)
Weight—M Models, add 300 lb (136 kg)	13,100 lb (5,942 kg)	13,700 lb (6,214 kg)	14,900 lb (6,759 kg)
Power Source	48V DC 8 x 6V 370 amp-hr	48V DC 8 x 6V 370 amp-hr	48V DC 8 x 6V 370 amp-hr
Generator Set—M models	45 amp Kubota	45 amp Kubota	45 amp Kubota
Available Options			
Padding for Platform	•	•	•
Light Package	•	•	•
UL® EE Rating	•	•	•
1200 Watt Inverter	•	•	•
Mesh to Top Rail—Bolt-on Aluminum	•	•	•

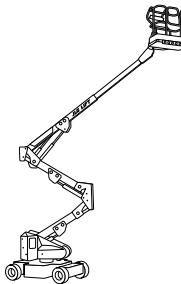

Main Features

- The fastest boom speeds in this class.
- ATC (Automatic Traction Control) improves performance on uneven surfaces.
- QuikCharge GenSet option provides automatic charging for continuous machine operation.
- Jib models provide access in and around confined work areas.

	E450A	E450AJ	M450AJ
E450 Series Articulating Boom Lifts			
Platform Height	45 ft (13.72 m)	45 ft (13.72 m)	45 ft (13.72 m)
Platform Capacity	500 lb (227 kg)	500 lb (227 kg)	500 lb (227 kg)
Horizontal Outreach	23 ft 1 in. (7.04 m)	23 ft 9 in. (7.24 m)	23 ft 9 in. (7.24 m)
Up and Over Height	24 ft 7 in. (7.49 m)	25 ft 3 in. (7.7 m)	25 ft 3 in. (7.7 m)
Overall Width	5 ft 9 in. (1.75 m)	5 ft 9 in. (1.75 m)	5 ft 9 in. (1.75 m)
Weight	12,600 lb (5,715 kg)	14,400 lb (6,532 kg)	14,700 lb (6,667 kg)
Power Source	48V DC 8 x 6V 370 amp-hr	48V DC 8 x 6V 370 amp-hr	48V DC 8 x 6V 370 amp-hr
Generator Set—H models	45 amp Kubota	45 amp Kubota	45 amp Kubota
Available Options			
Fall Arrest Platform 36 x 72 in. (0.91 x 1.83 m)	•	•	•
Padding for Platform	•	•	•
Solid Non-Marking Tires	•	•	•
UL® EE Rating	•	•	•
1200 Watt Inverter	•	•	•

JLG® Electric Powered Aerial Work Platforms SPECIFICATIONS

	E600J	M600J	E600JP	M600JP
E/M600 Electric Boom Series				
Platform Height	60 ft 4 in. (18.39 m)	60 ft 4 in. (18.39 m)	60 ft 4 in. (18.39 m)	60 ft 4 in. (18.39 m)
Platform Capacity	500 lb (227 kg)	500 lb (227 kg)	500 lb (227 kg)	500 lb (227 kg)
Horizontal Outreach	43 ft 3 in. (13.18 m)	43 ft 3 in. (13.18 m)	44 ft 5 in. (13.54 m)	44 ft 5 in. (13.54 m)
Overall Width	7 ft 11 in. (2.41 m)	7 ft 11 in. (2.41 m)	7 ft 11 in. (2.41 m)	7 ft 11 in. (2.41 m)
Weight	15,200 lb (6,895 kg)	15,500 lb (7,031 kg)	15,750 lb (7,144 kg)	16,050 lb (7,280 kg)
Power Source	48V DC, 8 x 6V 415 amp-hr	48V DC, 8 x 6V 415 amp-hr	48V DC, 8 x 6V 415 amp-hr	48V DC, 8 x 6V 415 amp-hr
Generator Set—M models		45 amp Diesel Kubota		45 amp Diesel Kubota

Available Options

30 x 48 in. (0.76 x 1.22 m) Platform	•	•	•	•
Fall Arrest Platform 36 x 72 in. (0.91 x 1.83 m)	•	•		
Mesh to Top Rail Bolt-on Aluminum	•	•	•	•
Soft Touch System 6 ft Platform Padding (30 x 72 in. Platform)	•	•		
1/2 in. Air Line to Platform	•	•	•	•
Foam-Filled Tires	•	•	•	•
1200 Watt Inverter	•	•	•	•
Hostile Environment Kit ¹	•	•	•	•
UL® EE Rating	•	•	•	•
Tow Package ²	•	•	•	•
Light Package ³	•	•	•	•
Platform Worklights	•	•	•	•
Flashing Amber Beacon	•	•	•	•

1. Includes console cover, boom wipers and cylinder bellows.
2. 2WD only.
3. Includes head and tail lights and platform work lights.

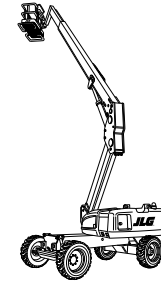

Main Features

- The world's first 60-foot electric boom—Indoor and outdoor versatility.
- Indoor advantages—Zero emissions, industry-leading noise reduction, non-marking tires and the lowest weight in its class.
- Outdoor advantages—Rugged design with all-wheel drive, automatic traction control and oscillating axle.
- Available with 45 amp Kubota diesel-powered generator to maintain battery charge level during extended outdoor use.

JLG® Electric Powered Aerial Work Platforms SPECIFICATIONS

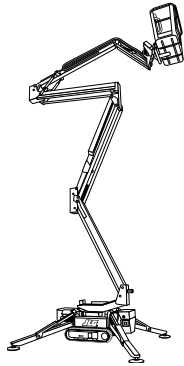

Main Features

- Low weight and rubber tracks for enhanced maneuverability and accessibility.
- Compact design increases ease of transport.
- Electric and combustion combination power for efficient energy usage.

	X430AJ	X500AJ	X600AJ	X770AJ
Compact Crawler Series Boom Lifts				
Platform Height	43 ft 6 in. (13.30 m)	49 ft (14.95 m)	59 ft 3 in. (18.05 m)	77 ft 5 in. (23.60 m)
Platform Capacity	500 lb (227 kg)	500 lb (227 kg)	500 lb (227 kg)	500 lb (227 kg)
Horizontal Reach	21 ft 7 in. (6.60 m)	23 ft (7.0 m)	30 ft (9.1 m)	43 ft (13.1 m)
Overall Width	29 in. (0.75 m)	31 in. (0.78 m)	31 in. (0.78 m)	31 in. (0.78 m)
Weight	4,392 lb (1,992 kg)	5,071 lb (2,300 kg)	6,571 lb (2,980 kg)	9,665 lb (4,384 kg)
Power Source				
Gasoline Engine	Honda iGX390 11.7 hp (8.7 kw)	Honda iGX390 11.7 hp (8.7 kw)	Honda iGX440 13 hp (9.5 kW)	
Diesel Engine				Kubota D902 21.6 hp (16.1 kW)
Electric Engine	100Ah 36V Lithium Ion	100Ah 48V Lithium-Ion	100Ah 72V Lithium-Ion	100Ah 83V Lithium-Ion



Main Features

- Versatile articulating jib provides up to 14 ft 6 in. (4.42 m) up and over reach.
- 360-degree rotating mast for unmatched positioning capabilities.
- Capacity for two workers and supplies.
- Drive through doorways and narrow aisles.
- Navigate around multiple obstacles on the ground and in the air.

	T20E	T26E	T32E
Toucan Series Mast-Style Boom Lifts			
Platform Height	20 ft 2 in. (6.14 m)	26 ft 6 in. (8.10 m)	32 ft 3 in. (9.83 m)
Platform Capacity—Unrestricted	500 lb (227 kg)	500 lb (227 kg)	500 lb (227 kg)
Horizontal Reach	6 ft 6.7 in. (1.99 m)	8 ft 8 in. (2.64 m)	15 ft 1 in. (4.60 m)
Overall Width	3 ft 3 in. (0.99 m)	3 ft 9 in. (1.14 m)	3 ft 10.8 in. (1.18 m)
Weight	5,360 lb (2,431 kg)	6,834 lb (3,100 kg)	9,480 lb (4,300 kg)
Power Source	24V 225 amp-hr	24V 240 amp-hr	48V 260 amp-hr
Available Options			
1/2 in. Air Line to Platform	•	•	•
Platform Worklights	•	•	•



JLG Industries, Inc.

1 JLG Drive
McConnellsburg, PA 17233-9533
Telephone 717-485-5161
Toll-free in US 877-JLG-LIFT
Fax 717-485-6417

www.jlg.com

An Oshkosh Corporation Company

Part No.: 3131565
R041718
Printed in USA

